



JR-A Series

Air Loaded Pressure Reducing Valves

GAS PRESSURE REDUCING VALVES

The LowFlow JR Series line of high pressure regulators have the ability to handle very high pressures and very low flows. These valves are typically used in research and sampling systems for general, corrosive and specialty gas service, and for non-cavitating liquids. Typical applications include gas chromatography and flame ionization detectors, as well as other industrial controls.

Features:

- Top entry design facilitates in-line cleaning and maintenance
- Barstock construction guarantees material integrity and surface finish
- High flow rate coupled with high rangeability reduces need for reduced trim sizes
- Optimized internal volume
- Proprietary Jorlon diaphragm material provides exceptionally long life
- Soft seat material for ANSI Class VI shutoff



A Division of
Richards Industrials
3170 Wasson Road
Cincinnati, OH 45209

513.533.5600
lowflow@richardsind.com

www.lowflowvalve.com

JR-A SERIES SPECIFICATIONS

Line Size: 1/4", 3/8", 1/2" (DN8, DN10, DN15)

End Connections

- SWE
- NPT

Soft Seat Materials for ANSI Class VI Shut-off

- PTFE to +150°F (+66°C)
- PEEK to +350°F (+177°C)

Body Material

- 316L SST – Standard
- Contact factory for other body/trim/seat materials

Diaphragm Material: Jorlon

Maximum Inlet Pressure: 2000 psig (138 bar)

Pressure at Maximum Temperature: 2000 psi @ 350°F (138 bar @ 177°C) with PEEK seat; 2000 psi @ 150°F (138 bar @ 66°C) with PTFE seat

Maximum Pressure Drop: 1975 psi (136 bar)

Air Loaded Set Points: 25 – 750 psi (1,7 – 52 bar)

Flow Characteristics

- Cv 0.012
- Cv 0.08
- Cv 0.20

Maximum Inlet Pressure: 2000 psi (138 bar)

JR-A SERIES TRIM FLOW GRAPHS

- FLOW CAPACITIES FOR SETPOINTS UP TO 25 PSI (0.012 Cv)

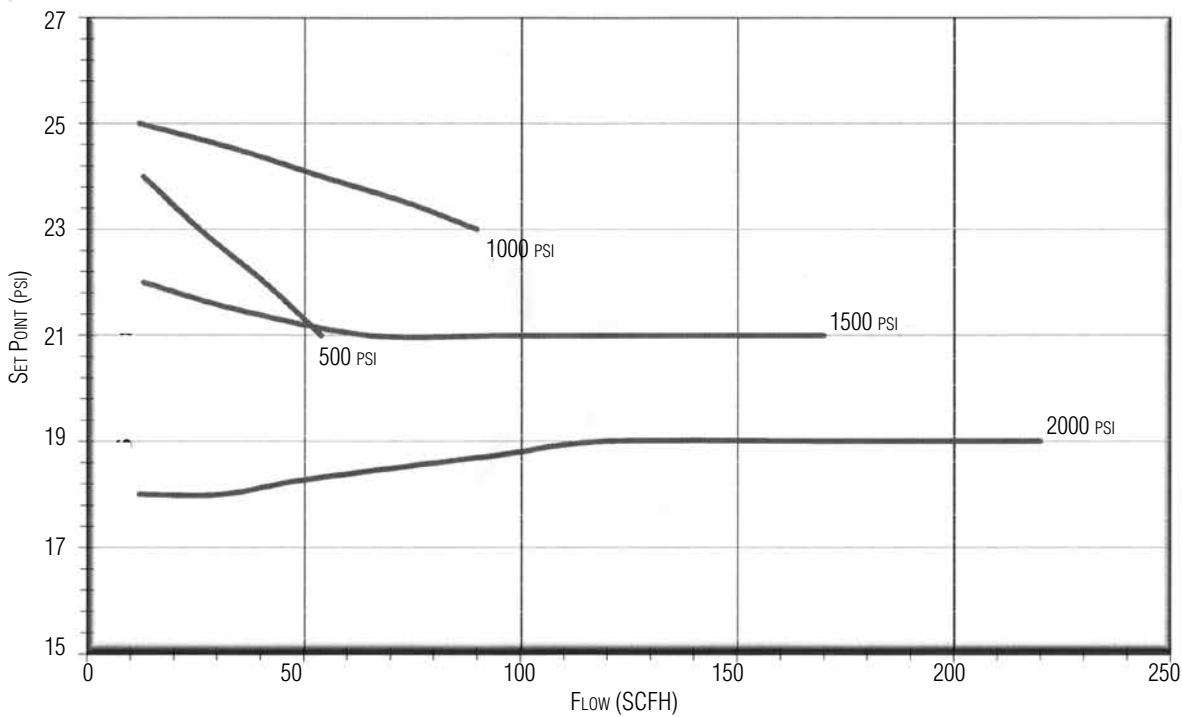

JR-A SERIES TRIM FLOW GRAPHS

- FLOW CAPACITIES FOR SETPOINTS UP TO 100 PSI (0.012 Cv)

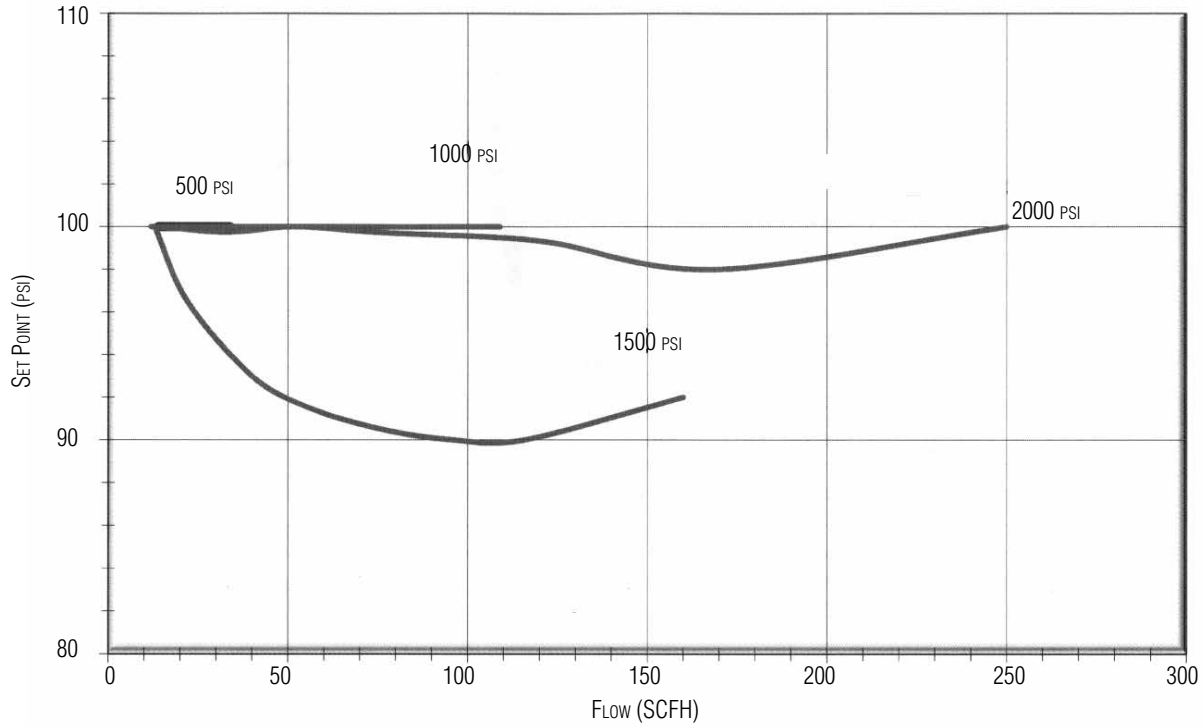

- FLOW CAPACITIES FOR SETPOINTS UP TO 250 PSI (0.012 Cv)

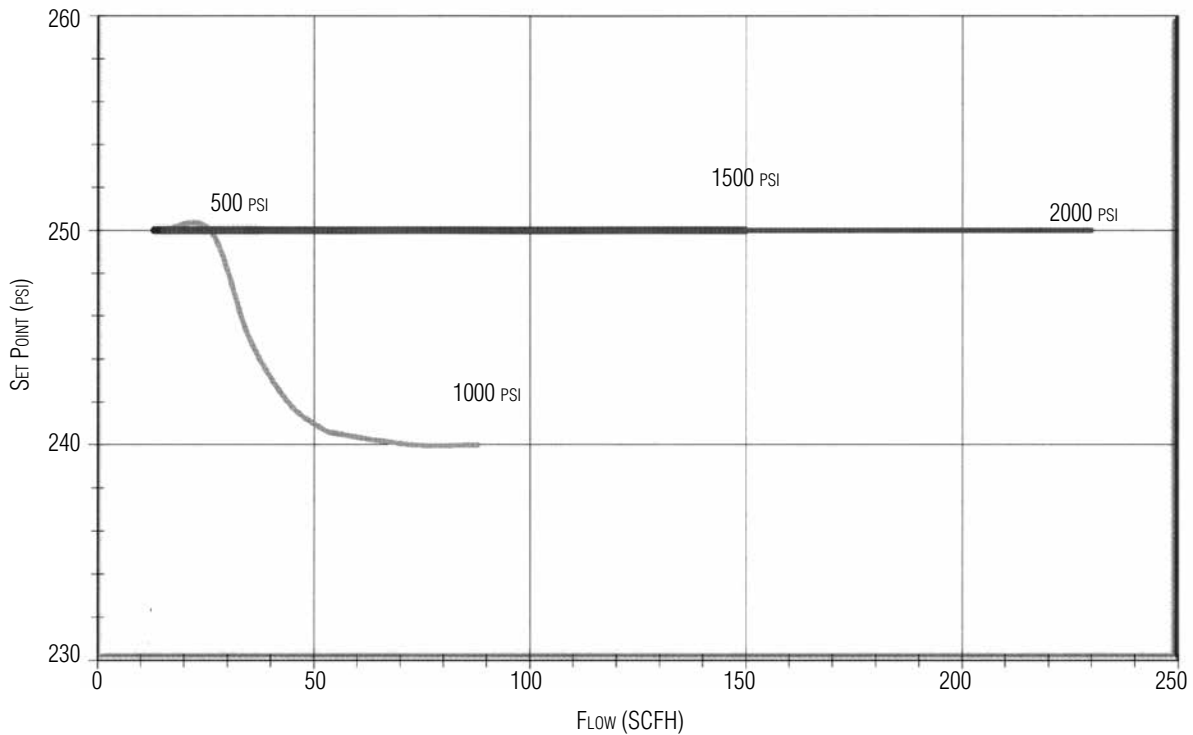

JR-A SERIES TRIM FLOW GRAPHS

- FLOW CAPACITIES FOR SETPOINTS UP TO 500 PSI (0.012 Cv)

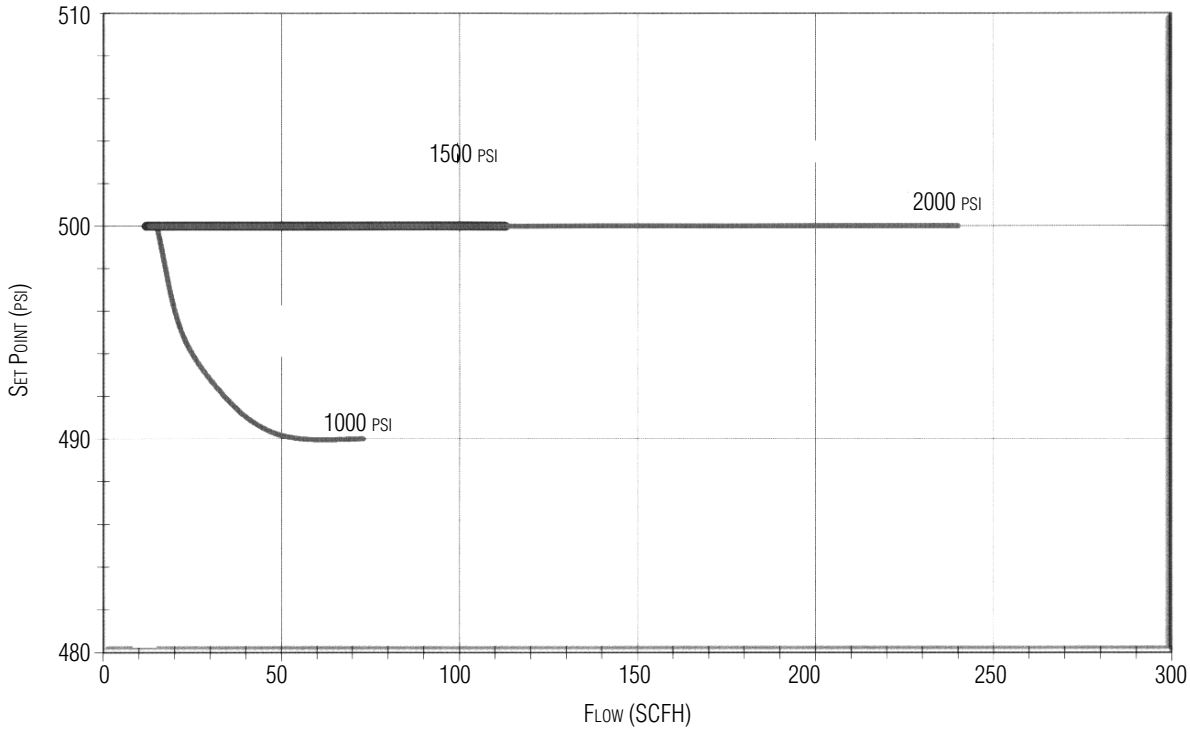

- FLOW CAPACITIES FOR SETPOINTS UP TO 25 PSI (0.08 Cv)

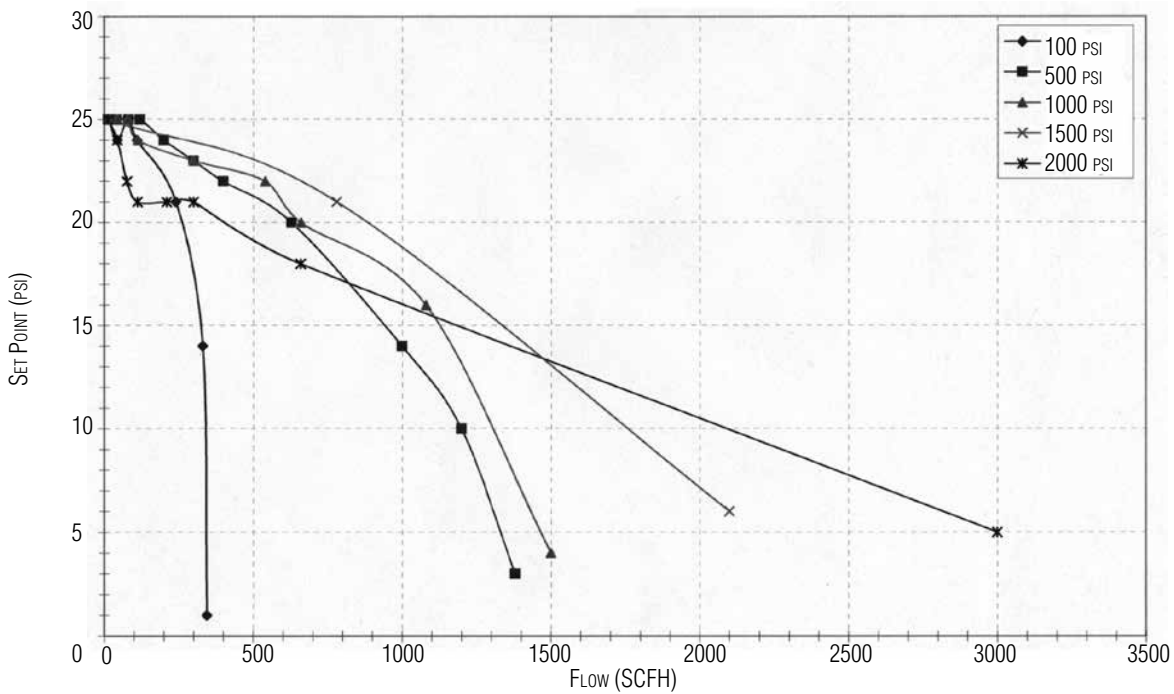

JR-A SERIES TRIM FLOW GRAPHS

- FLOW CAPACITIES FOR SETPOINTS UP TO 100 PSI (0.08 Cv)

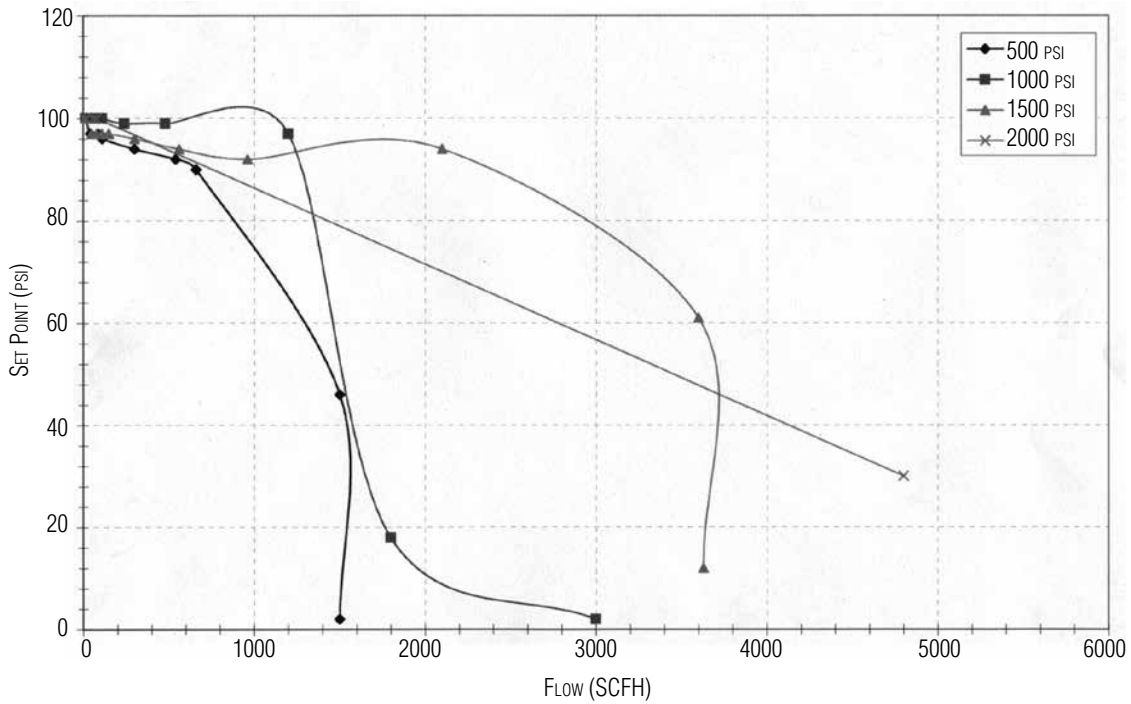

- FLOW CAPACITIES FOR SETPOINTS UP TO 250 PSI (0.08 Cv)

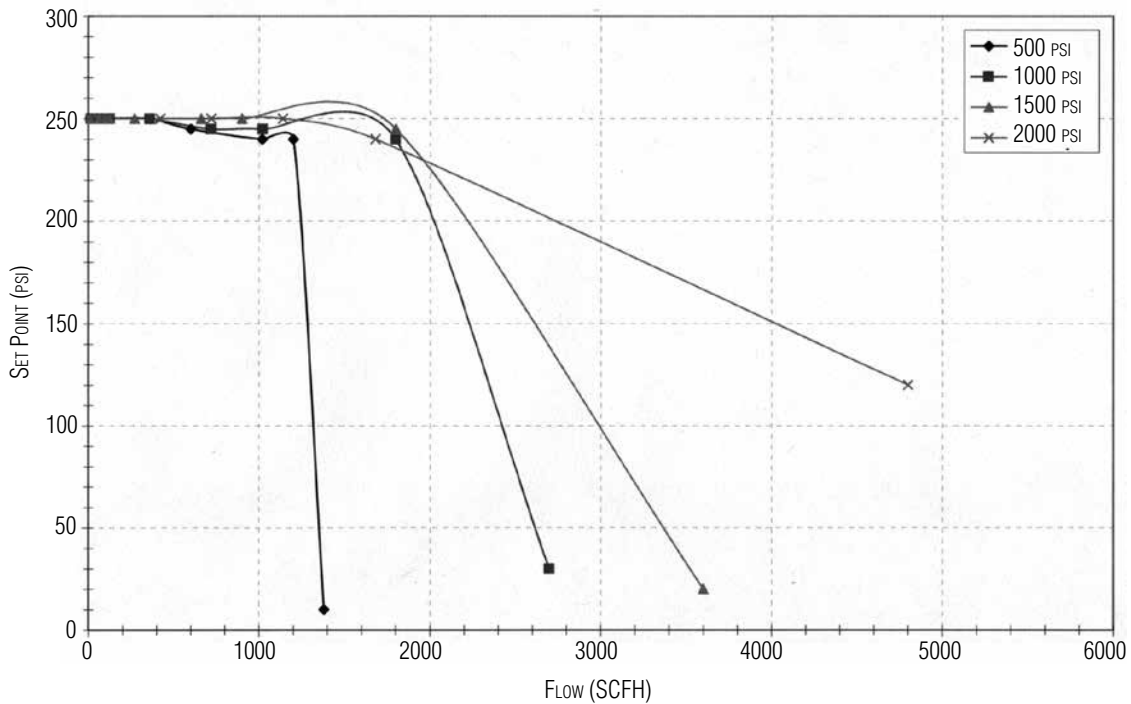

JR-A SERIES TRIM FLOW GRAPHS

- FLOW CAPACITIES FOR SETPOINTS UP TO 500 PSI (0.08 Cv)

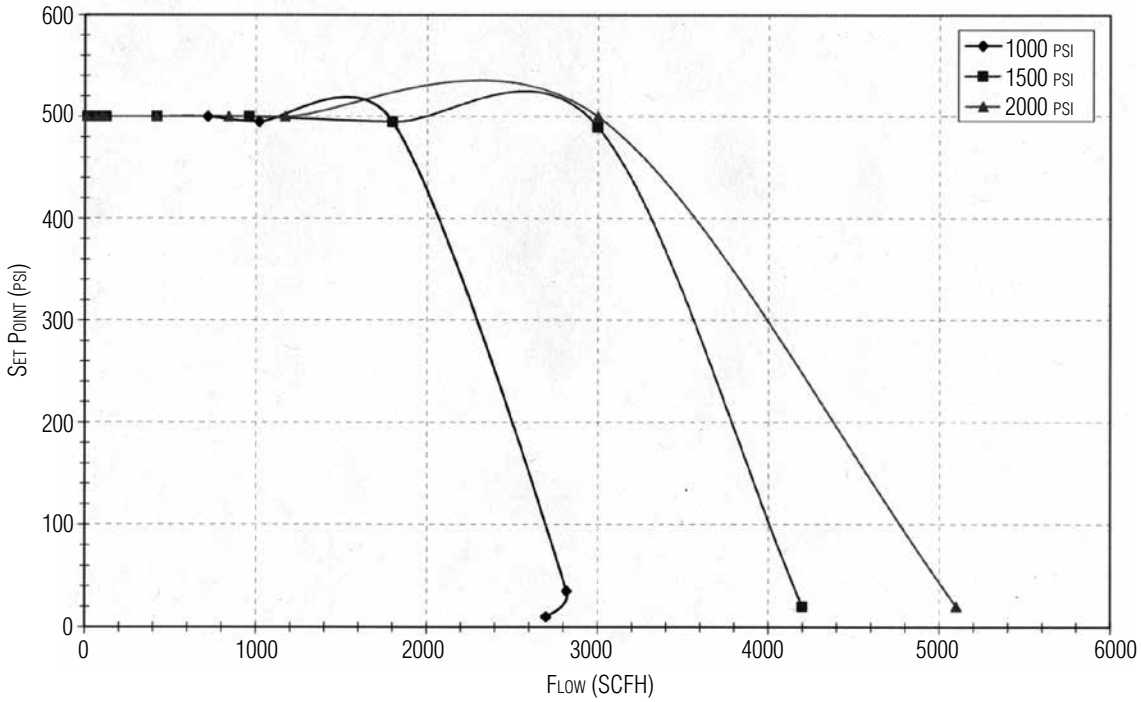

JR-A SERIES FLOW DIMENSIONS

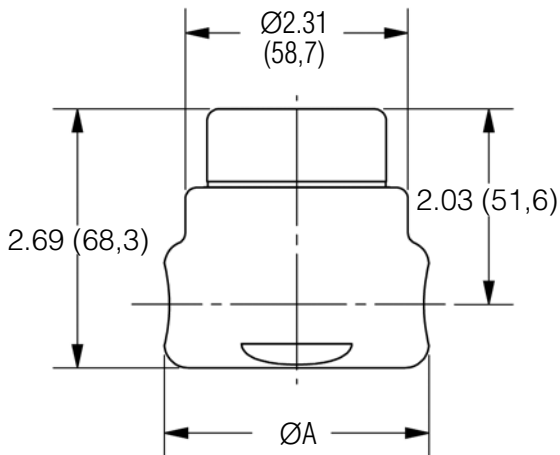

- **JR-A Series, Inches**

VALVE SIZE	DIMENSIONS, INCHES A	WEIGHT, LBS
1/4"	2.00	3.4
3/8"	2.00	3.4
1/2"	2.75	4.2

- **JR-A Series, Metric**

VALVE SIZE	DIMENSIONS, MM A	WEIGHT, KGS
DN8	50,8	1,5
DN10	50,8	1,5
DN15	69,9	1,9

SPECIFICATIONS



JR-A SERIES FLOW CONFIGURATIONS

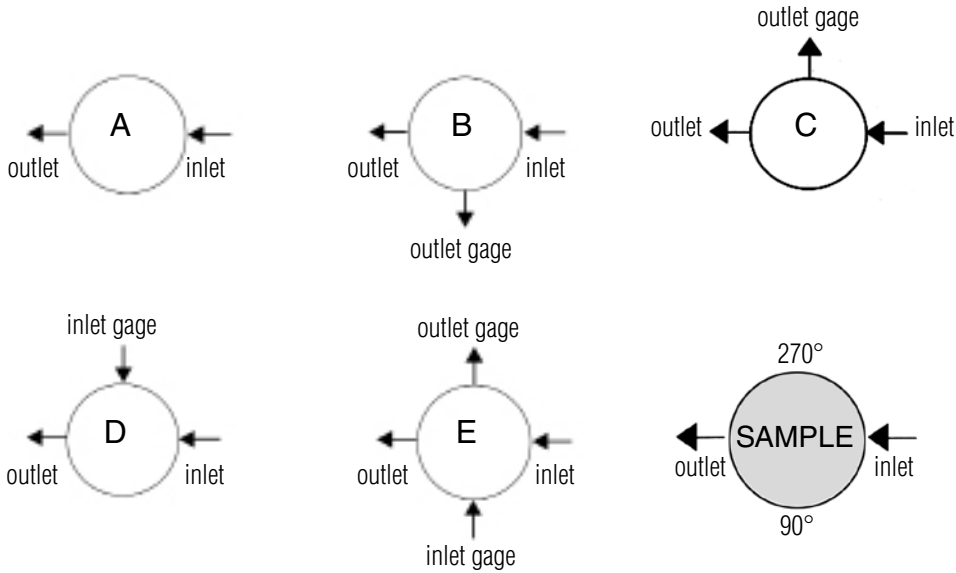

* Gage ports are 1/4" FNPT (consult factory for required alternative)
 Consult factory for other porting options

JR-A SERIES ORDERING SCHEMATIC

To order an air loaded version of the JR Series valve, please refer to the JR Series Product Designator, and order option E7 Range Spring and OutletPressure (box 7 & 8) and option AA for Diaphragm Material (box 9 & 10) and Actuator (box 11 & 12).