

JRHL Series

Pressure Reducing Valves for Low Flow and Low Pressure Process Gas

GAS PRESSURE REDUCING VALVE

The JRHL Series line of low flow pressure regulators have the ability to handle low set pressures and very low flows with less offset than valves with smaller diaphragms.

The durable valve body and metal trim components are machined from ASTM A479 316L SST barstock. The valve is outfitted with the rugged Jorlon diaphragm and Teflon, PEEK or EPDM seats for ANSI Class VI shutoff.

FEATURES

- In-line removable seat and trim facilitates in-line cleaning and maintenance
- Barstock construction guarantees material integrity and quality surface finish
- Two Cv offerings of 0.8 and 0.5 and four spring ranges guarantees a valve that will fit your application
- Optimized internal volume
- Proprietary Jorlon diaphragm material provides exceptionally long life
- Soft seat material for ANSI Class VI shutoff
- Can be used on continuous clean steam, and on non-cavitating fluids

APPLICATIONS

Ideal for production facilities and equipment which require gas flow regulation.

- Air
- Nitrogen
- Carbon Dioxide
- Argon
- Oxygen
- Custom purge or blanket gas



A Division of
Richards Industrials
3170 Wasson Road
Cincinnati, OH 45209

513.533.5600
lowflow@richardsind.com

www.lowflowvalve.com

JRHL SERIES SPECIFICATIONS

Line Size: 1/2" (DN15), 3/4" (DN20)

End Connections: NPT, contact factory for other options

Soft Seat Materials for ANSI Class VI Shut-off

- PTFE to +150°F (66°C)
- PEEK to +350°F (177°C)
- EPDM to +275°F (135°C)

Diaphragm Material: Jorlon, PTFE™

Body and Trim Material

- 316L SST- Standard
- Contact factory for other body/trim materials

Maximum Inlet Pressure: 250 psig (17,2 bar)

Pressure at Maximum Temperature:

- 250 psi @ 150°F (17,2 bar @ 66°C) with PTFE seats
- 250 psi @ 350°F (17,2 bar @ 177°C) with PEEK seats
- 250 psi @ 275°F (17,2 bar @ 135°C) with EPDM seats

Maximum Pressure Drop: 250 psi (17,2 bar)

Spring Ranges

- 1 – 5 psi (0,07 – 0,34 bar)
- 5 – 15 psi (0,34 – 1,03 bar)
- 15 – 25 psi (1,03 – 1,72 bar)
- 25 – 50 psi (1,72 – 3,45 bar)

Flow Characteristics: Cv 0.5, Cv 0.8

Options

- Panel Mounting
- Captured Vent
- Oxygen or Oil Free Cleaning
- Self Relieving
- Tamper Proof

OPTIONS & DEFINITIONS

Captured Vent The captured vent design provides maximum safety for the user when handling toxic or hazardous media. It features a 1/8" FNPT port located on the spring housing. The user can easily tube this vent to a safe location. This option can be incorporated into a self-relieving regulator that provides an additional port to permit the safe expulsion of hazardous media.

Panel Mount The panel mount feature utilizes a threaded spring housing and a panel mount ring to secure the regulator to an instrument panel. This option requires a 1-1/2" panel cut out.

Self Relieving The self relieving option is used for internal venting of downstream pressure. From a practical standpoint, it allows for immediate reduction in pressure setpoints and automatically alleviates regulator lock up.

Tamper Proof The tamper proof option replaces the standard adjusting knob with a stainless steel acorn nut.

Lockout Device The lockout device is a 2 piece polypropylene enclosure which encapsulates the adjustment knob and prevents unwanted set point changes. The part number required for this valve is 26970. (Lock not included)

FEATURES AND BENEFITS

Reliable, gas pressure regulation at flows less than 1 LPM and set points to 1 psig (69 millibar)

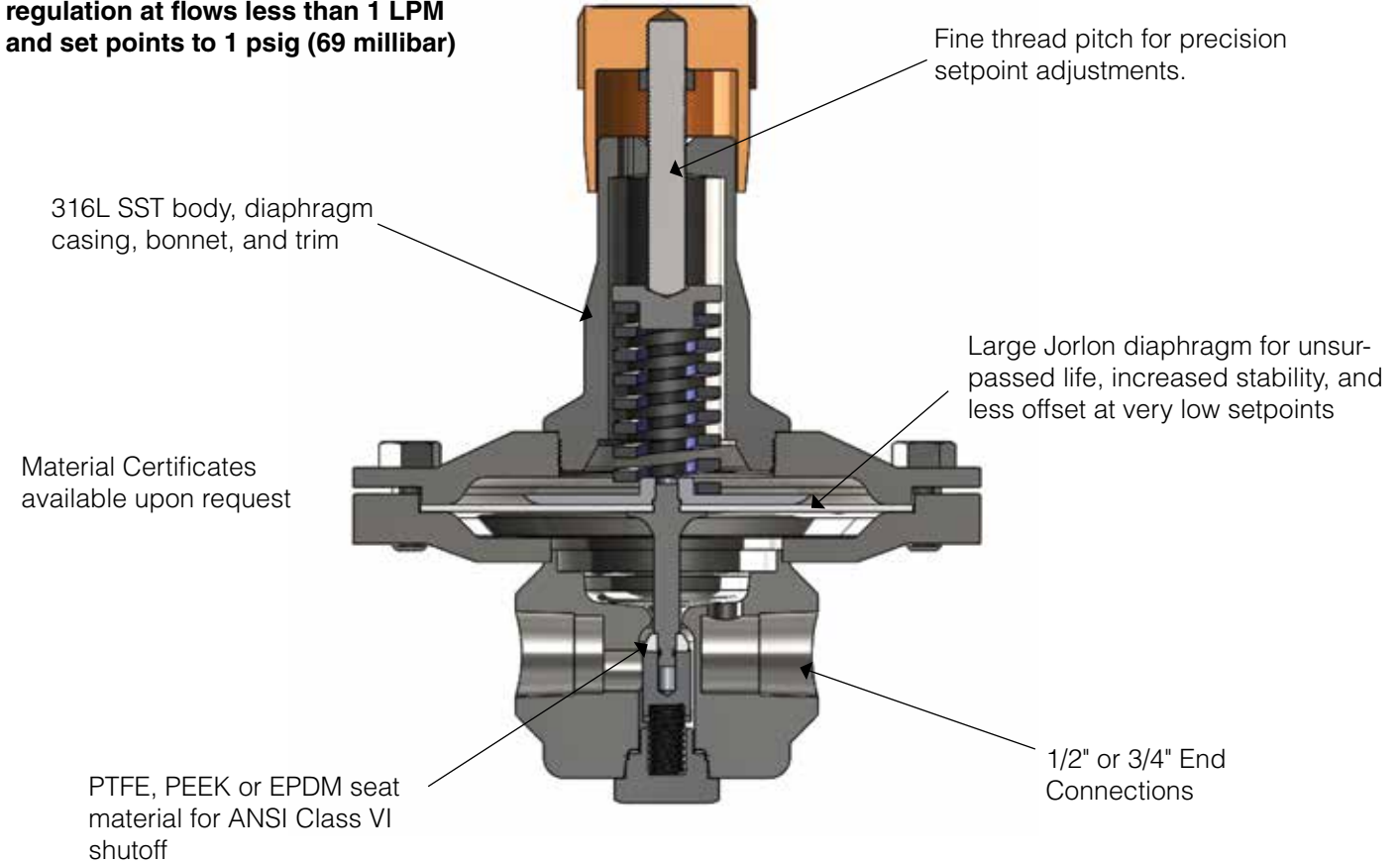

LOW CONFIGURATIONS

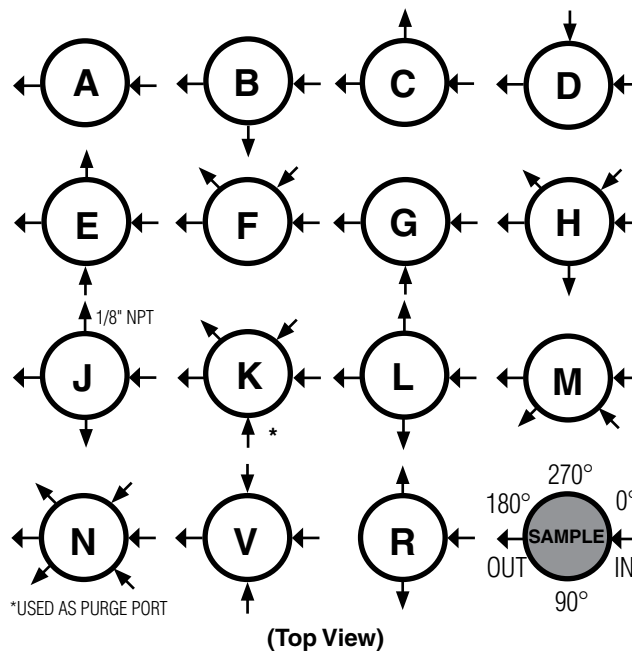

DIMENSIONS

JRHL 1/2" & 3/4" with NPT Ends

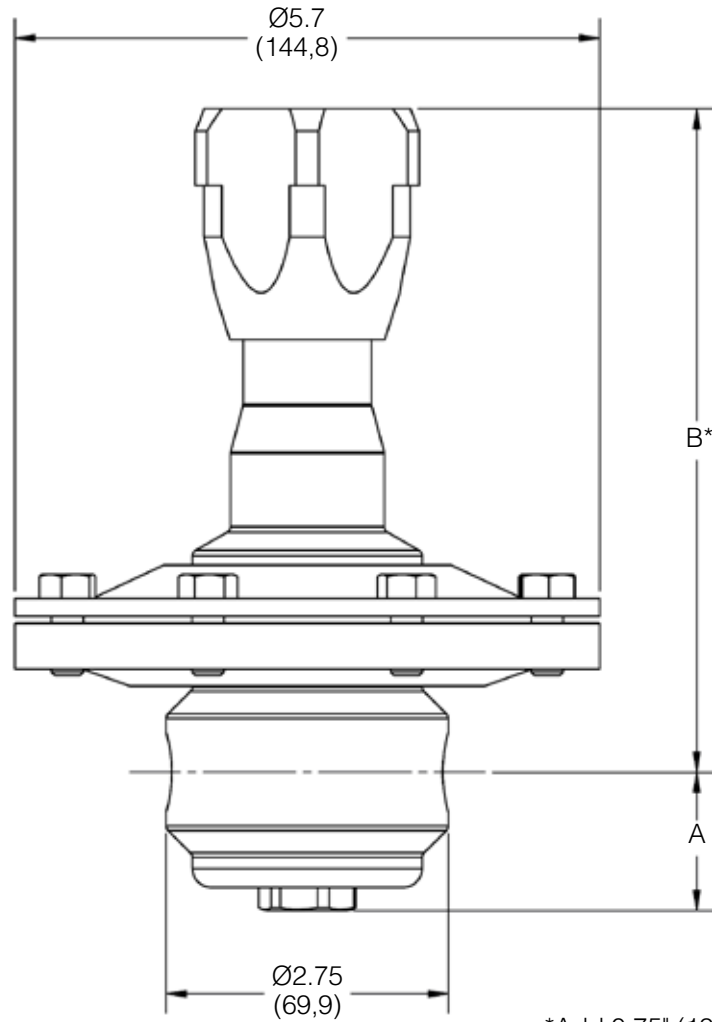

*Add 0.75" (19,1) for Easy Removal

VALVE SIZE	A	B
1/2"	1.35" (34,3mm)	6.50" (165,1mm)
3/4"	1.48" (37,6mm)	6.63" (168,4mm)

SIZING

All of the following sizing charts for the JRHL were derived using Nitrogen as the flow medium at ambient conditions. In order to convert your gas to the equivalent volume of Nitrogen, multiply your application's flow by the appropriate multiplying factor.

GAS	Specific Gravity	Multiplying Factor
Air	1	1.02
Ammonia	0.596	0.79
Argon	1.379	1.19
Arsine	2.695	1.67
CO	0.967	1
CO2	1.529	1.26
Ethylene	0.975	1

GAS	Specific Gravity	Multiplying Factor
Helium	0.138	0.38
Hydrogen	0.07	0.27
Methane	0.555	0.76
Natural Gas	0.555	0.76
Nitrogen	0.967	1
Oxygen	1.105	1.07
Propane	0.495	0.72

For all other gaseous media, use the following formula to calculate the appropriate multiplying factor.

(Sg = Specific Gravity of the media)

$$\frac{1}{\sqrt{\frac{0.967}{Sg(\text{any gas})}}}$$

Cv TRIM SELECTION INSTRUCTIONS

1. Select a graph on the following sixteen pages that best represents your outlet pressure set point and flow range.
2. Select the inlet pressure line on the graph (horizontal sloped line, P1) that reflects your application's actual inlet pressure.
3. That line indicates the Pressure/Flow capabilities of the Cv trim under flowing conditions

FLOW DATA FOR CV TRIM SELECTION

The graphs illustrate the change or "droop" in outlet pressures as the flow rate increases, and the lockup (setpoint rise) as flow decreases and approaches zero.

Maximum inlet pressure: 250 psig (17,2 bar)

Flow Coefficient: 0.5

Range Spring: 1-5 psig (0,07-0,34 bar)

Set Point: 1 psig

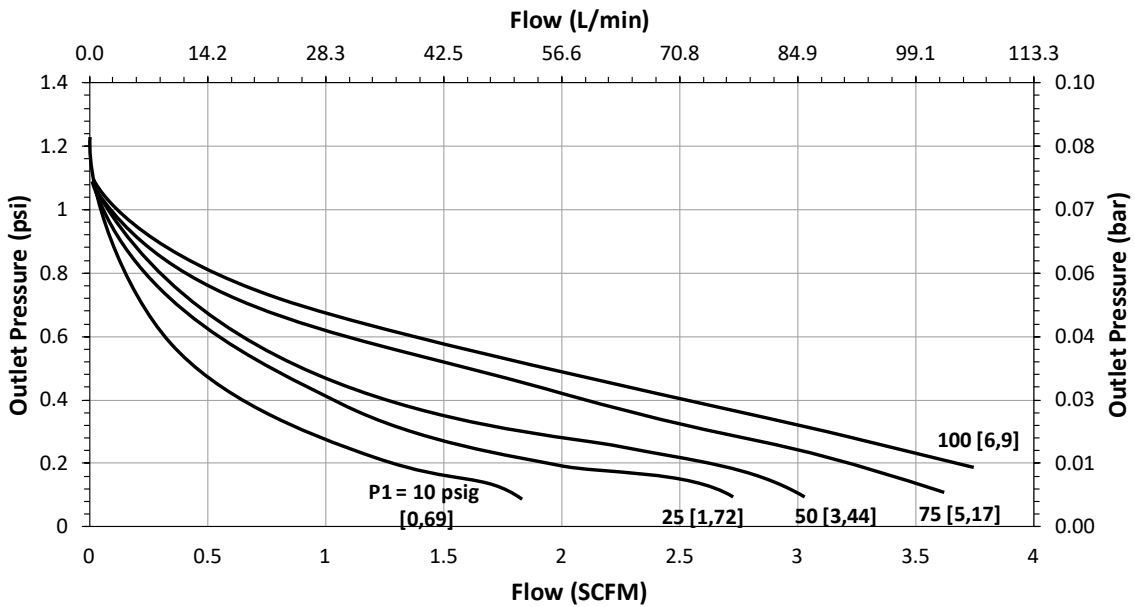

Flow Coefficient: 0.5

Range Spring: 1-5 psig (0,07-0,34 bar)

Set Point: 1 psig

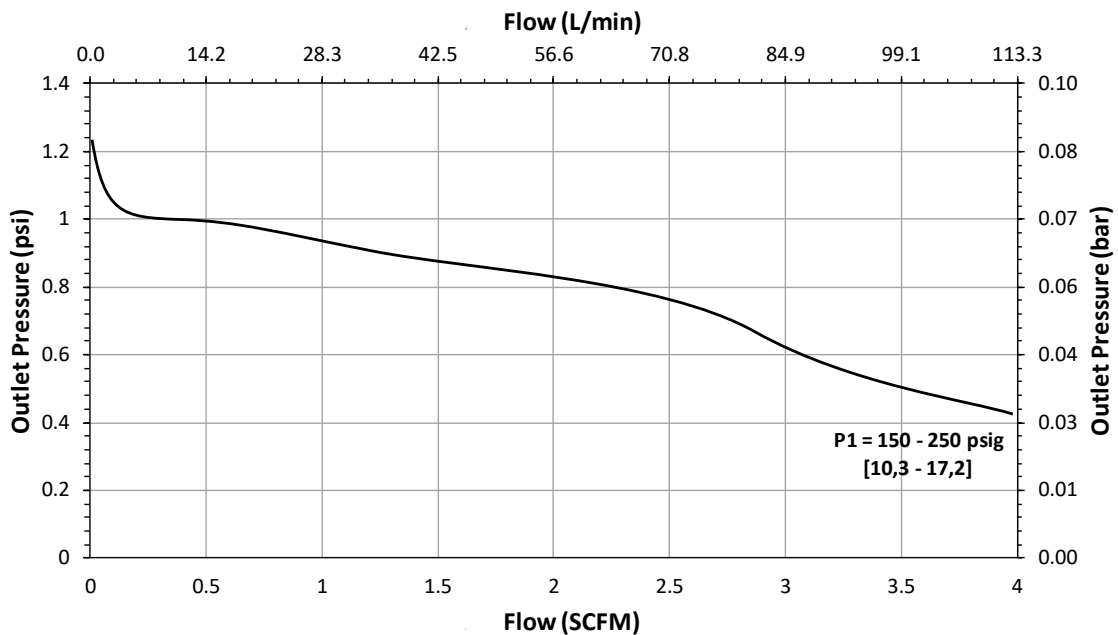

FLOW DATA FOR CV TRIM SELECTION

The graphs illustrate the change or "droop" in outlet pressures as the flow rate increases, and the lockup (setpoint rise) as flow decreases and approaches zero.

Maximum inlet pressure: 250 psig (17,2 bar)

Flow Coefficient: 0.5

Range Spring: 1-5 psig (0,07-0,34 bar)

Set Point: 2 psig

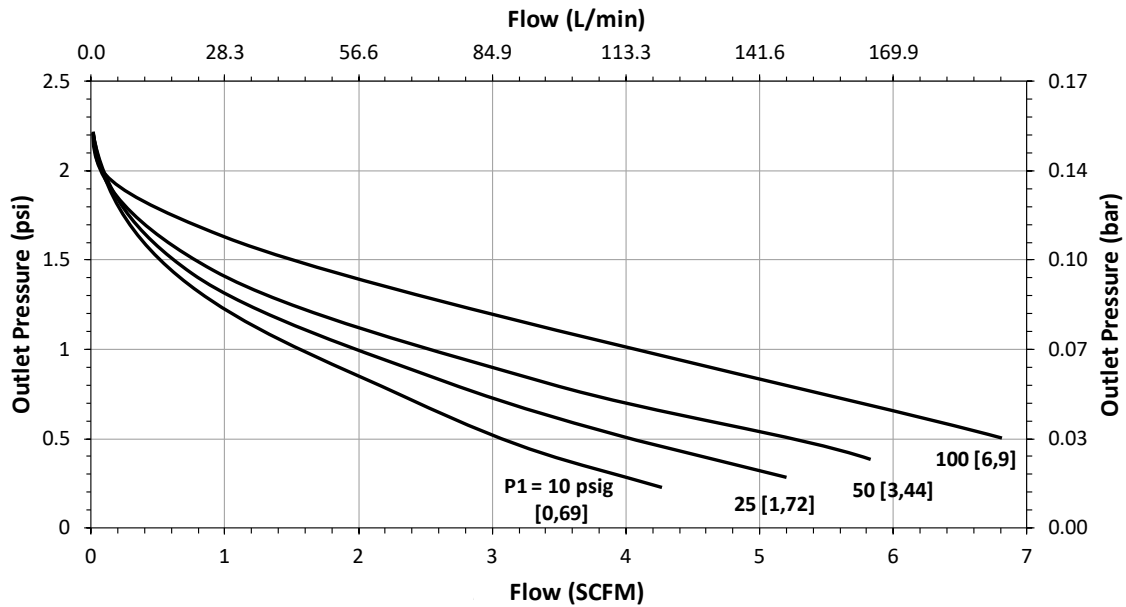

Flow Coefficient: 0.5

Range Spring: 1-5 psig (0,07-0,34 bar)

Set Point: 2 psig

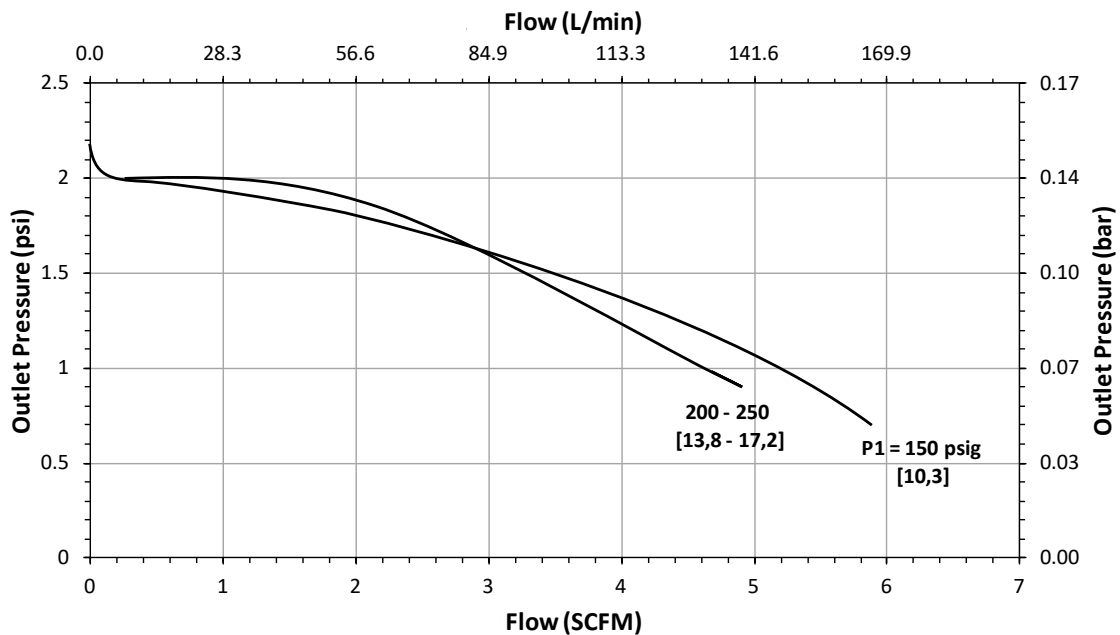

FLOW DATA FOR CV TRIM SELECTION

The graphs illustrate the change or "droop" in outlet pressures as the flow rate increases, and the lockup (setpoint rise) as flow decreases and approaches zero.

Maximum inlet pressure: 250 psig (17,2 bar)

Flow Coefficient: 0.5

Range Spring: 1-5 psig (0,07-0,34 bar)

Set Point: 5 psig

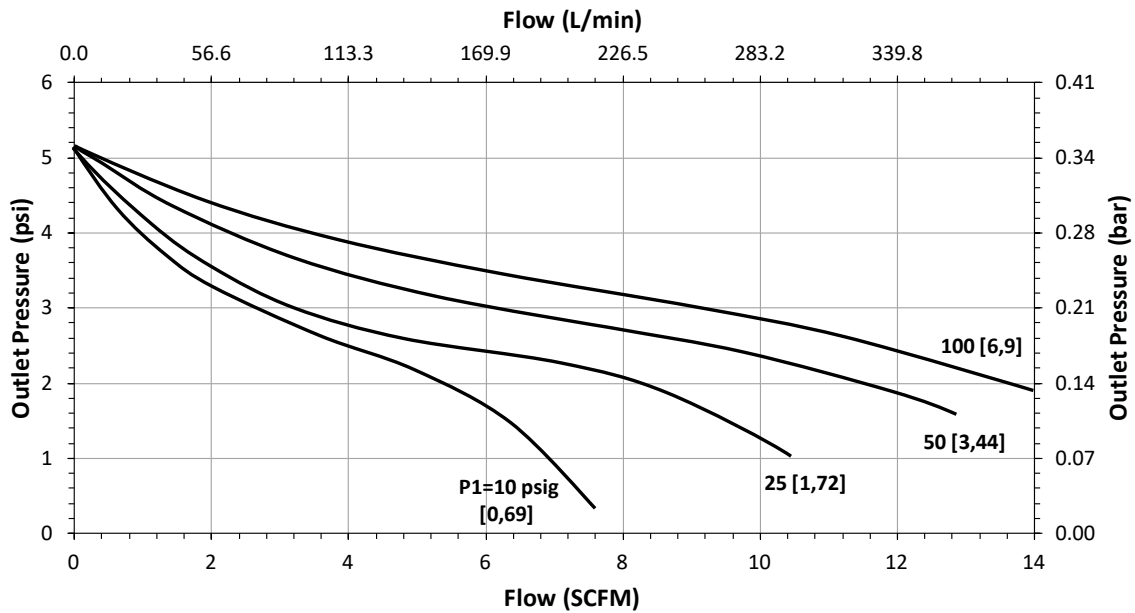

Flow Coefficient: 0.5

Range Spring: 1-5 psig (0,07-0,34 bar)

Set Point: 5 psig

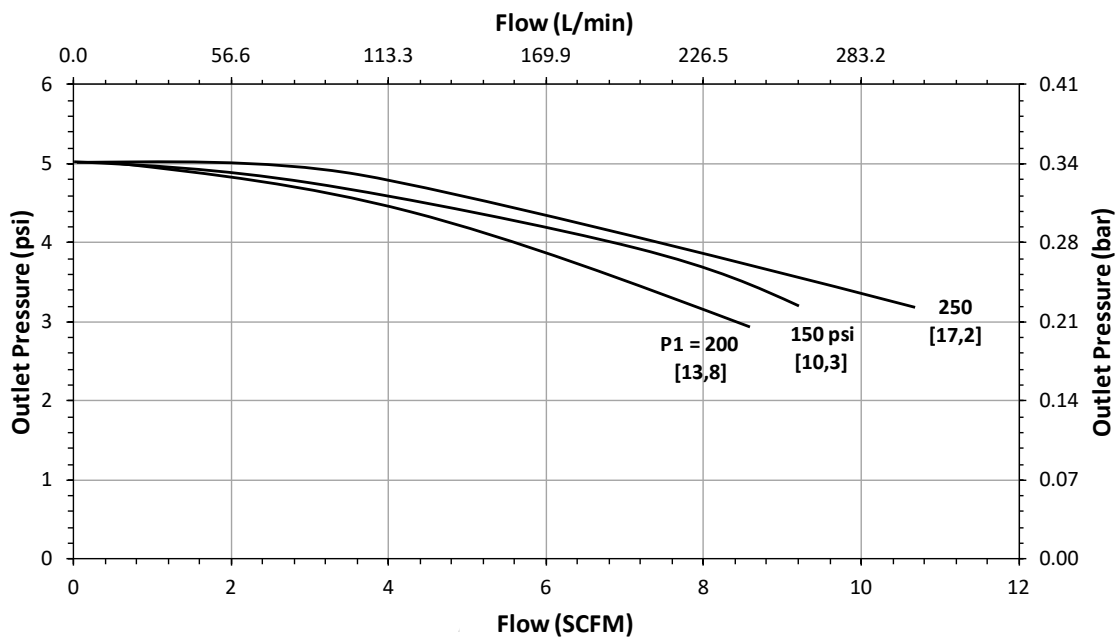

FLOW DATA FOR CV TRIM SELECTION

The graphs illustrate the change or "droop" in outlet pressures as the flow rate increases, and the lockup (setpoint rise) as flow decreases and approaches zero.

Maximum inlet pressure: 250 psig (17,2 bar)

Flow Coefficient: 0.5

Range Spring: 5-15 psig (0,34-1 bar)

Set Point: 10 psig

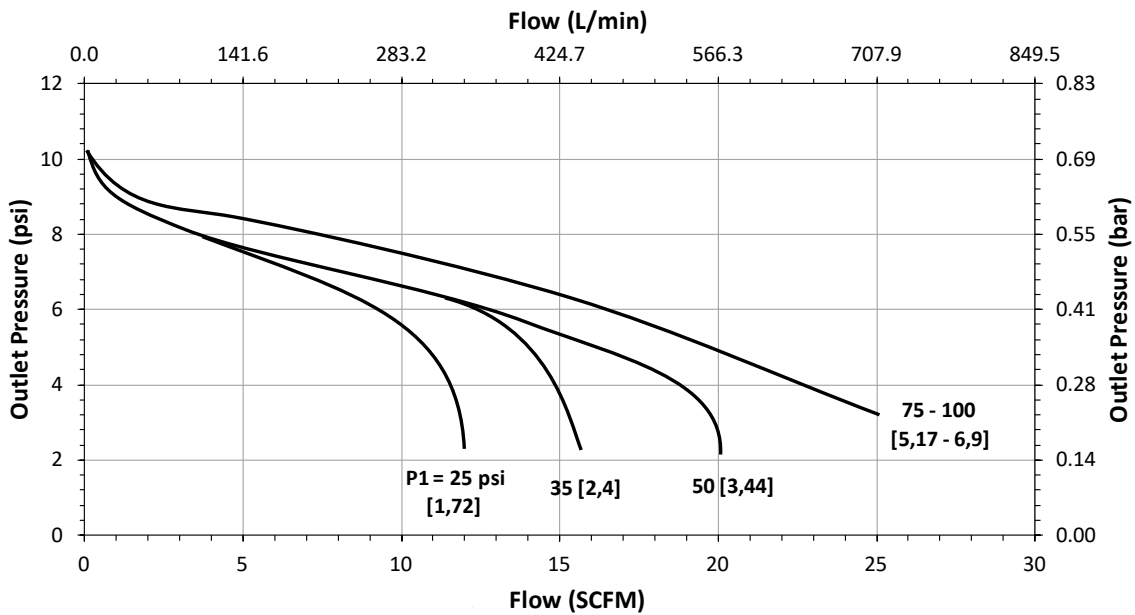

Flow Coefficient: 0.5

Range Spring: 5-15 psig (0,34-1 bar)

Set Point: 10 psig

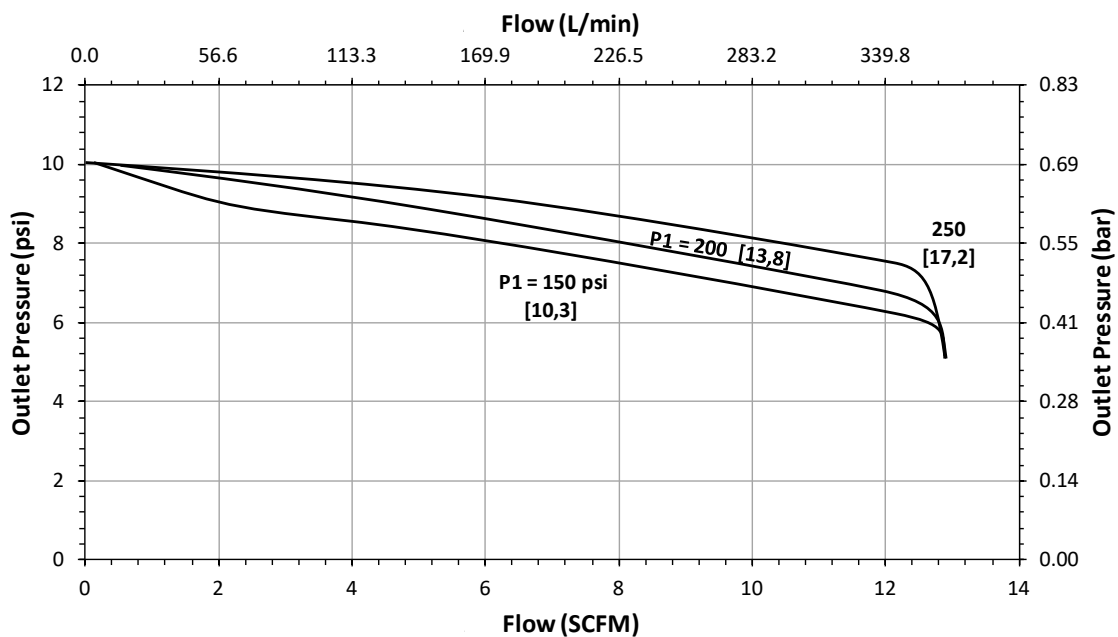

FLOW DATA FOR CV TRIM SELECTION

The graphs illustrate the change or "droop" in outlet pressures as the flow rate increases, and the lockup (setpoint rise) as flow decreases and approaches zero.

Maximum inlet pressure: 250 psig (17,2 bar)

Flow Coefficient: 0.5

Range Spring: 5-15 psig (0,34-1 bar)

Set Point: 15 psig

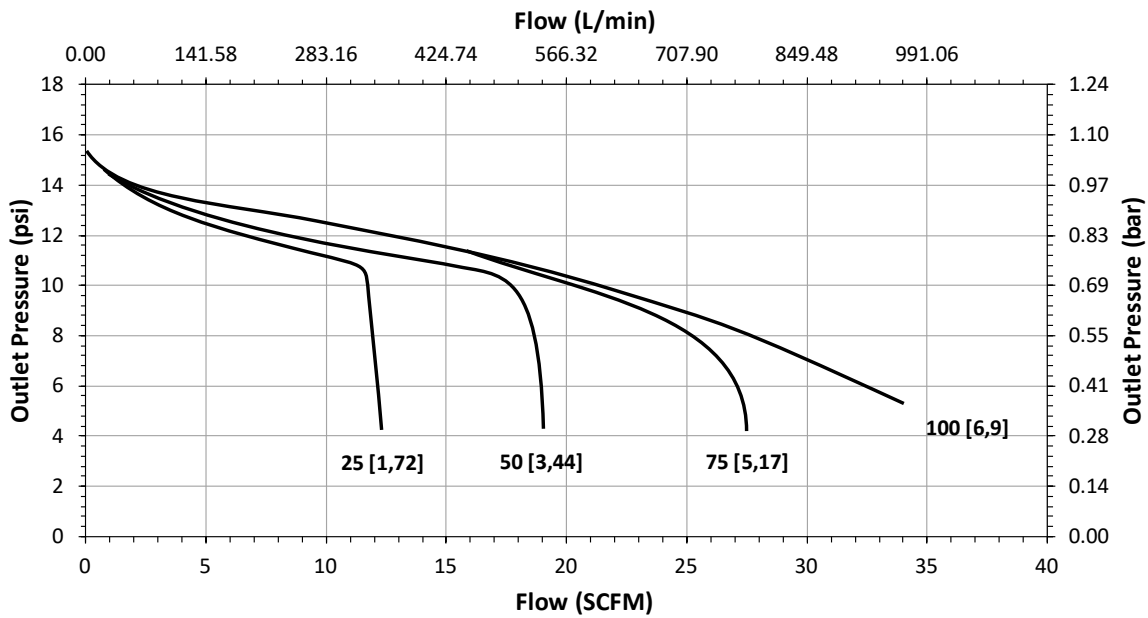

Flow Coefficient: 0.5

Range Spring: 5-15 psig (0,34-1 bar)

Set Point: 15 psig

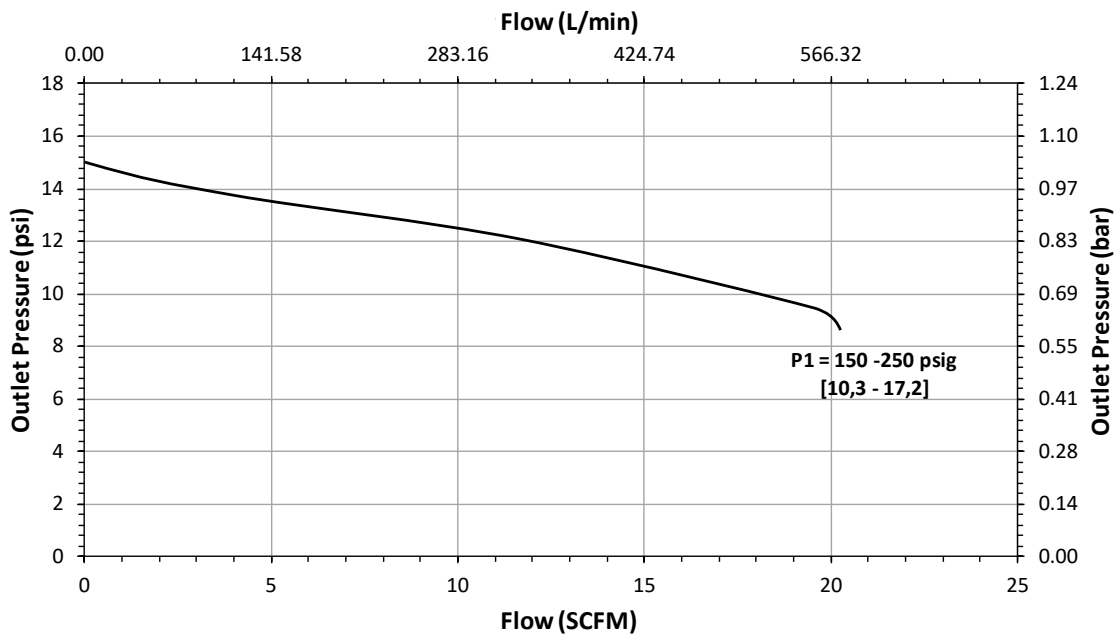

FLOW DATA FOR CV TRIM SELECTION

The graphs illustrate the change or "droop" in outlet pressures as the flow rate increases, and the lockup (setpoint rise) as flow decreases and approaches zero.

Maximum inlet pressure: 250 psig (17,2 bar)

Flow Coefficient: 0.5

Range Spring: 15-25 and 25-50 psig (1-1,7 bar and 1,7-3,4 bar)

Set Point: 20 psig/ 30 psig

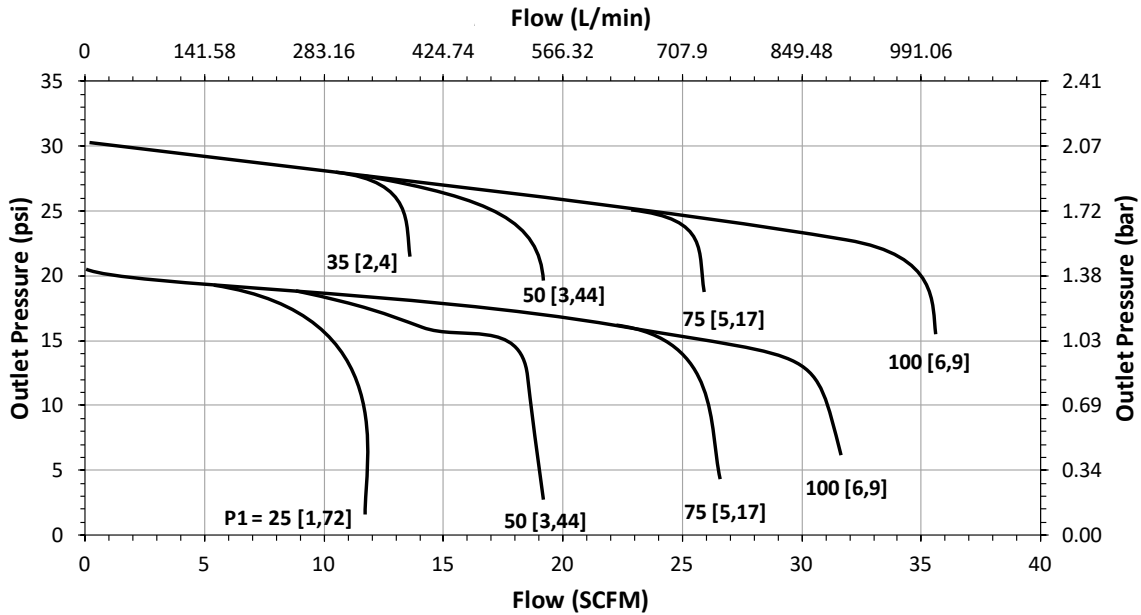

Flow Coefficient: 0.5

Range Spring: 15-25 and 25-50 psig (1-1,7 bar and 1,7-3,4 bar)

Set Point: 20 psig/ 30 psig

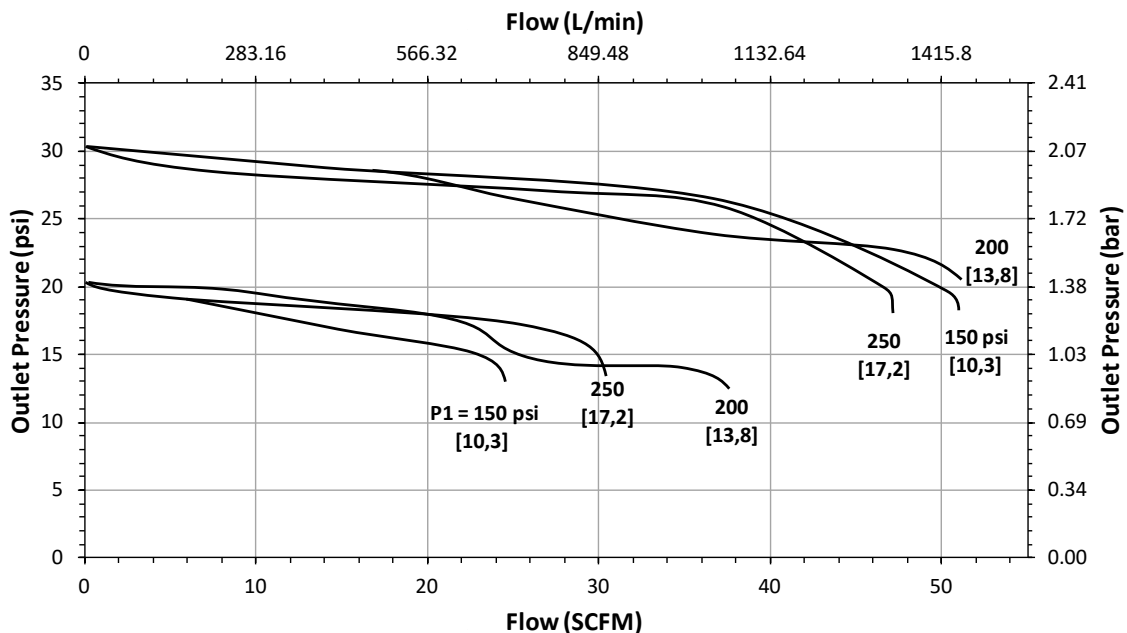

FLOW DATA FOR CV TRIM SELECTION

The graphs illustrate the change or "droop" in outlet pressures as the flow rate increases, and the lockup (setpoint rise) as flow decreases and approaches zero.

Maximum inlet pressure: 250 psig (17,2 bar)

Flow Coefficient: 0.5

Range Spring: 25-50 psig (1,7-3,4 bar)

Set Point: 25 psig / 35 psig

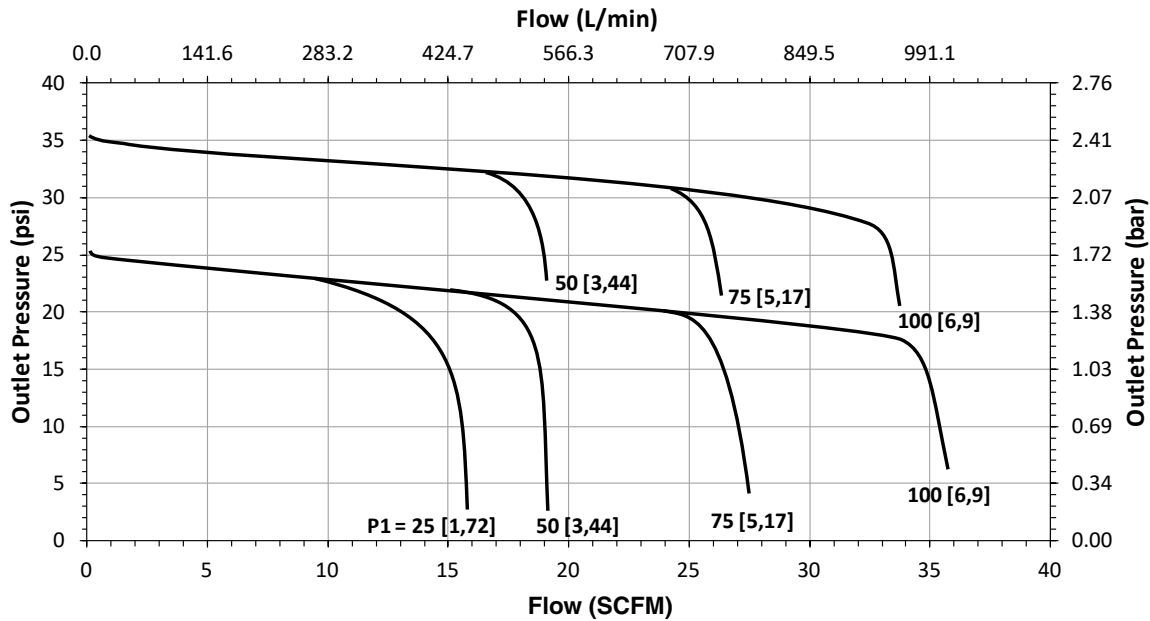

Flow Coefficient: 0.5

Range Spring: 25-50 psig (1,7-3,4 bar)

Set Point: 25 psig / 35 psig

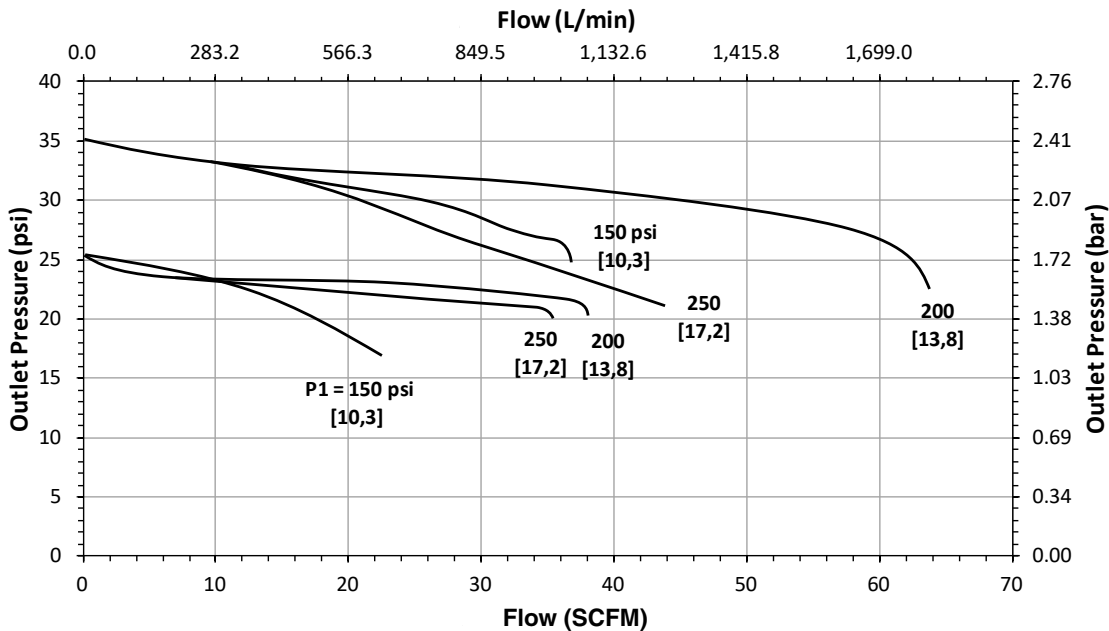

FLOW DATA FOR CV TRIM SELECTION

The graphs illustrate the change or "droop" in outlet pressures as the flow rate increases, and the lockup (setpoint rise) as flow decreases and approaches zero.

Maximum inlet pressure: 250 psig (17,2 bar)

Flow Coefficient: 0.5

Range Spring: 25-50 psig (1,7-3,4 bar)

Set Point: 40 psig / 50 psig

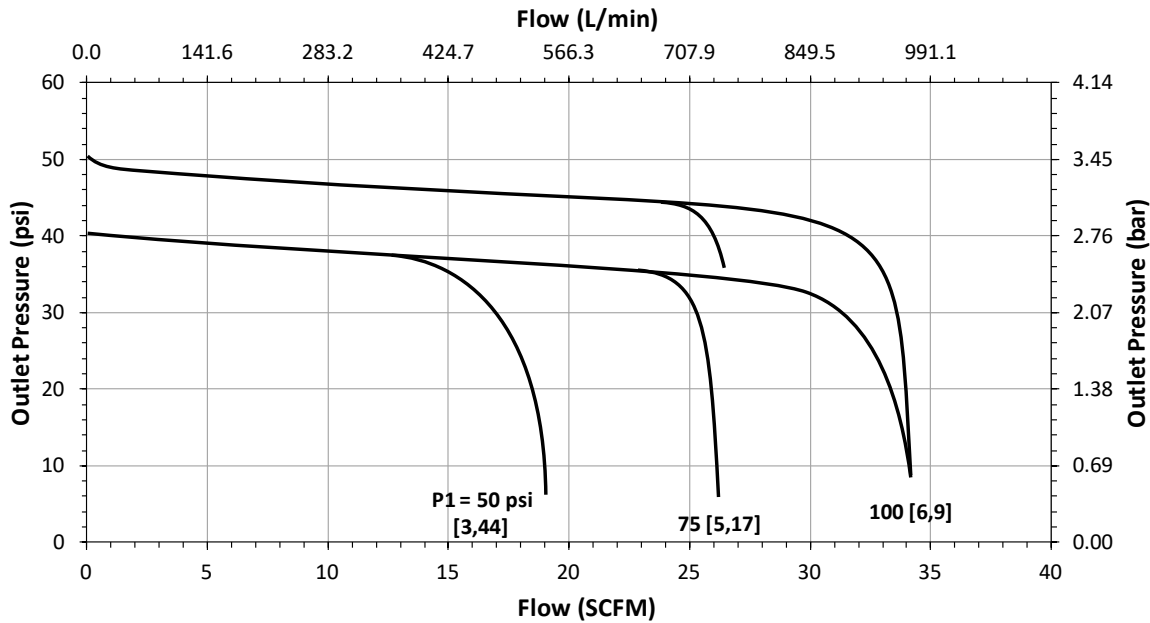

Flow Coefficient: 0.5

Range Spring: 25-50 psig (1,7-3,4 bar)

Set Point: 40 psig / 50 psig

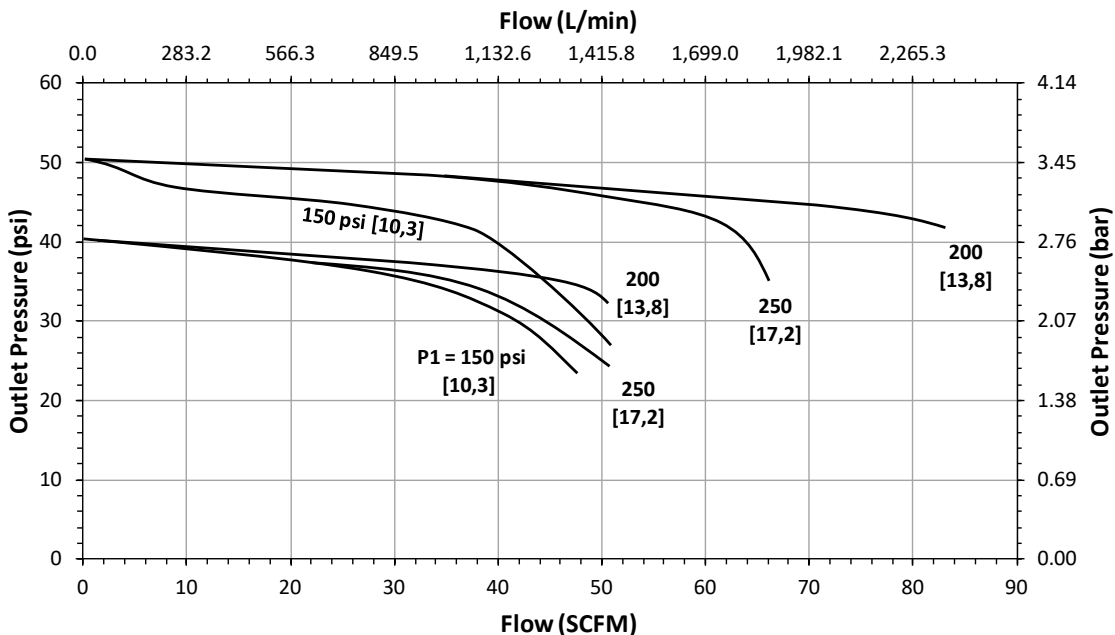

FLOW DATA FOR CV TRIM SELECTION

The graphs illustrate the change or "droop" in outlet pressures as the flow rate increases, and the lockup (setpoint rise) as flow decreases and approaches zero.

Maximum inlet pressure: 250 psig (17,2 bar)

Flow Coefficient: 0.8

Range Spring: 1-5 psig (0,07-0,34 bar)

Set Point: 1 psig

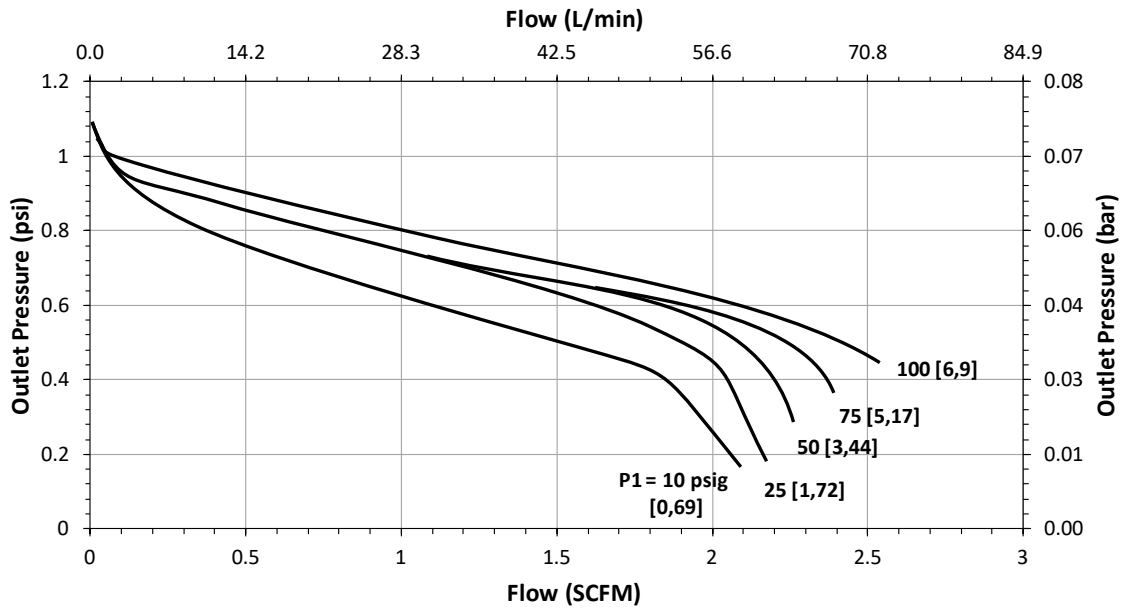

Flow Coefficient: 0.8

Range Spring: 1-5 psig (0,07-0,34 bar)

Set Point: 1 psig

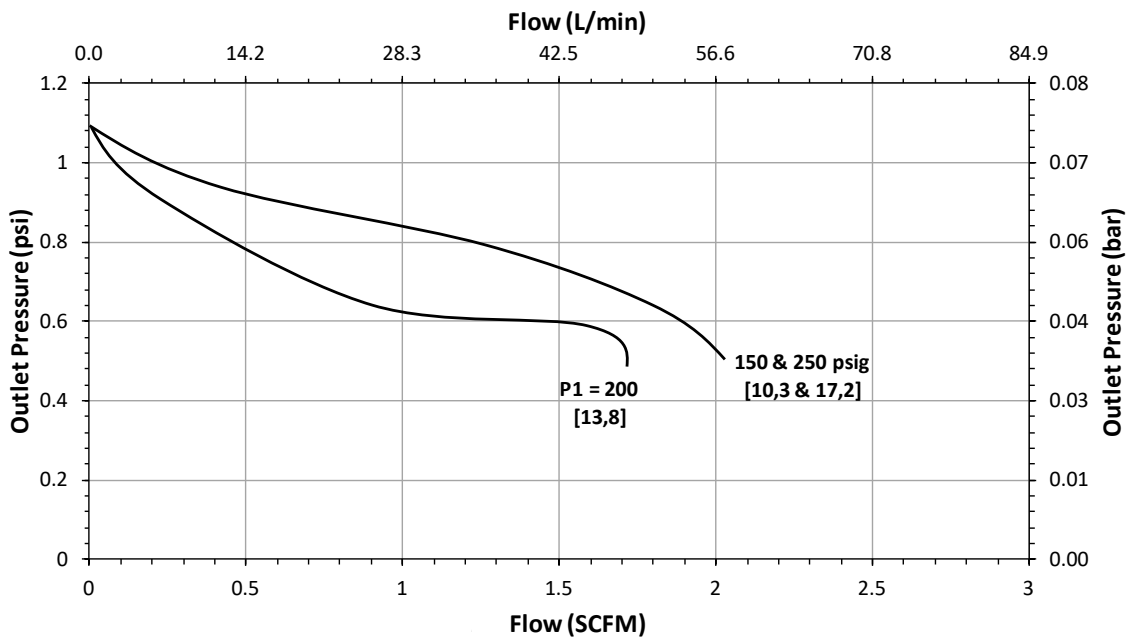

FLOW DATA FOR CV TRIM SELECTION

The graphs illustrate the change or "droop" in outlet pressures as the flow rate increases, and the lockup (setpoint rise) as flow decreases and approaches zero.

Maximum inlet pressure: 250 psig (17,2 bar)

Flow Coefficient: 0.8

Range Spring: 1-5 psig (0,07-0,34 bar)

Set Point: 2 psig

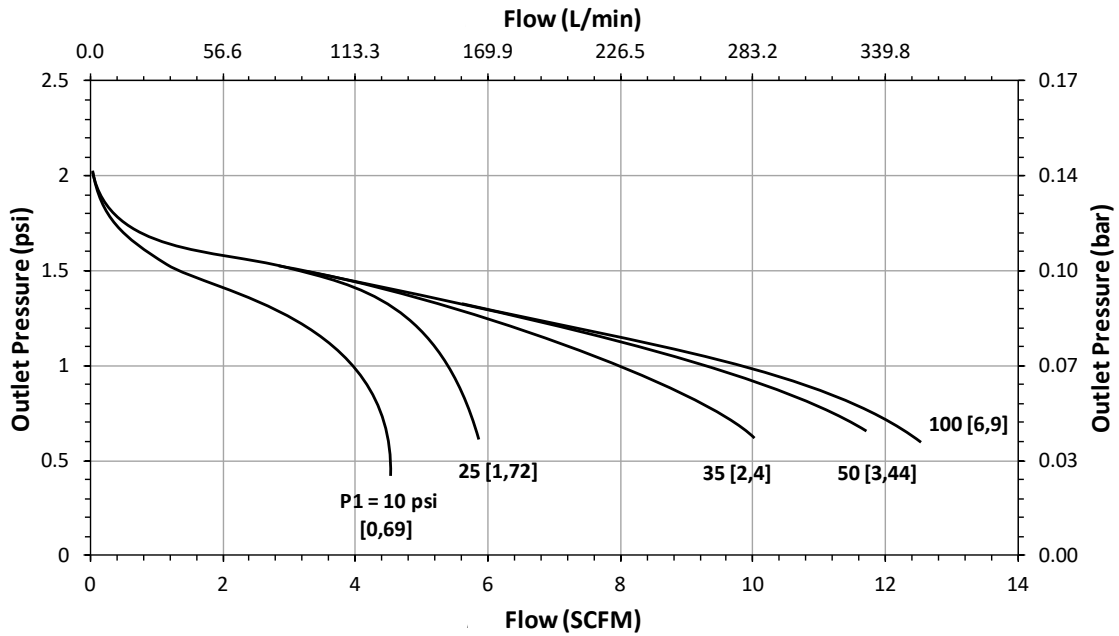

Flow Coefficient: 0.8

Range Spring: 1-5 psig (0,07-0,34 bar)

Set Point: 2 psig

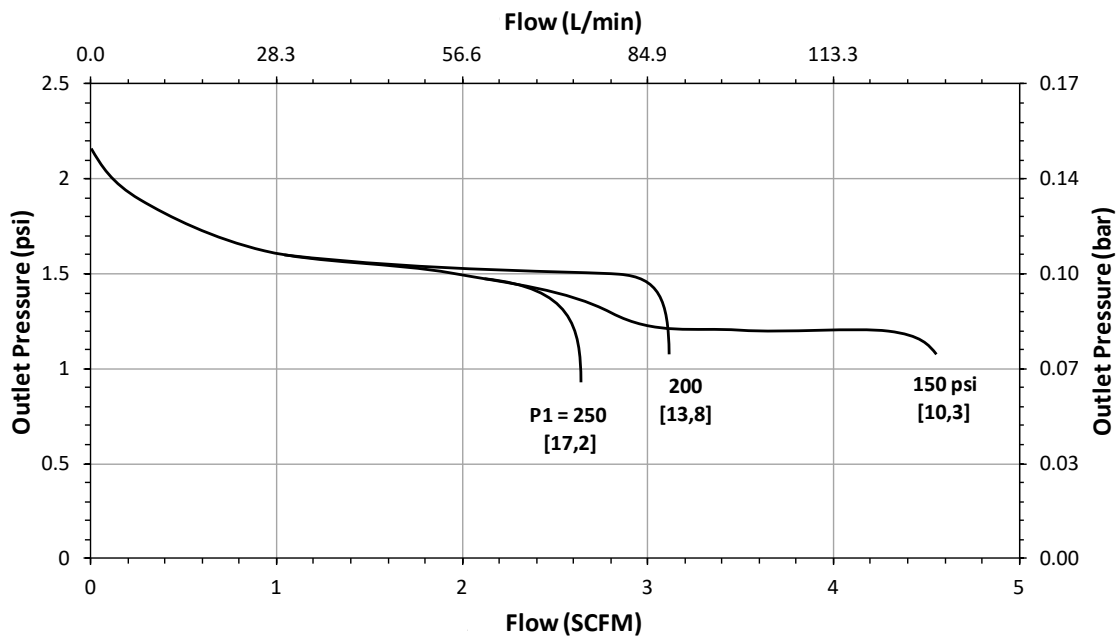

FLOW DATA FOR CV TRIM SELECTION

The graphs illustrate the change or "droop" in outlet pressures as the flow rate increases, and the lockup (setpoint rise) as flow decreases and approaches zero.

Maximum inlet pressure: 250 psig (17,2 bar)

Flow Coefficient: 0.8

Range Spring: 1-5 psig (0,07-0,34 bar)

Set Point: 5 psig

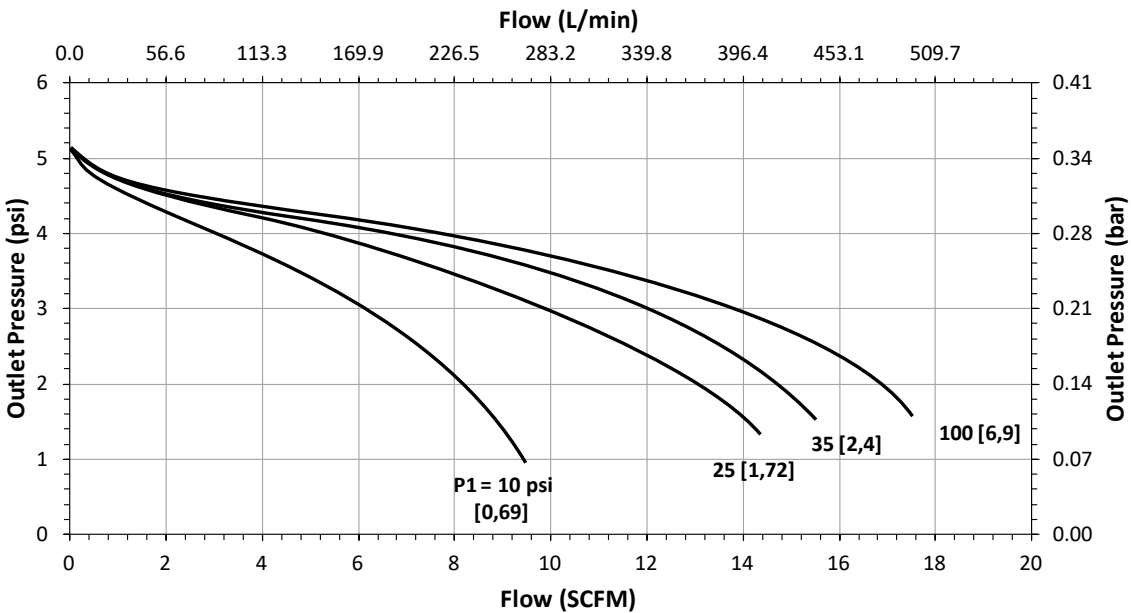

Flow Coefficient: 0.8

Range Spring: 1-5 psig (0,07-0,34 bar)

Set Point: 5 psig

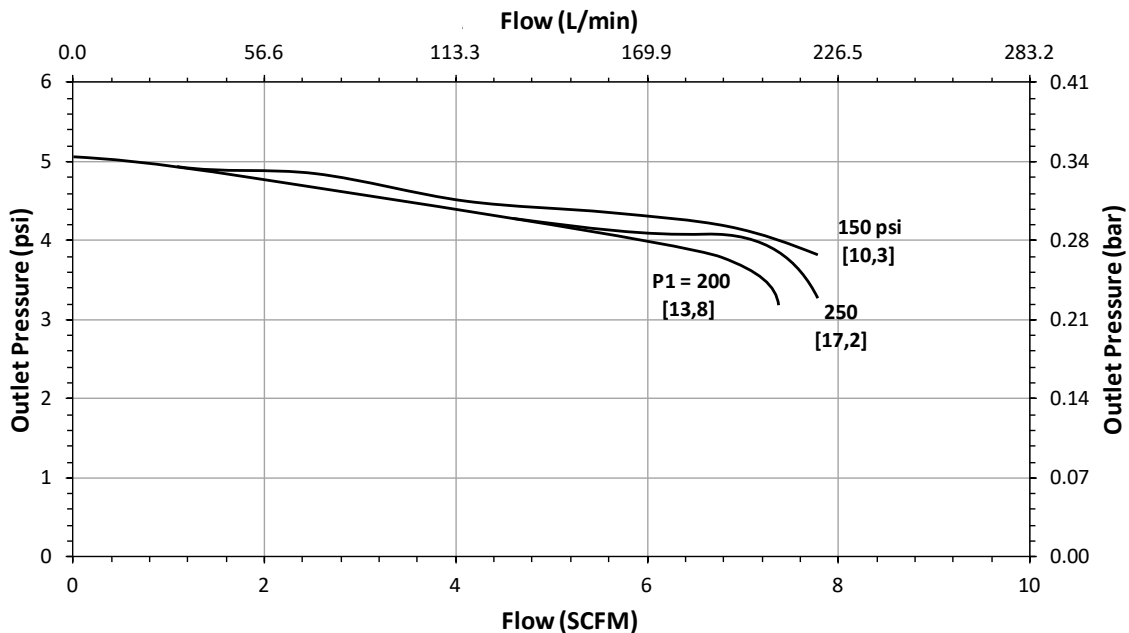

FLOW DATA FOR CV TRIM SELECTION

The graphs illustrate the change or "droop" in outlet pressures as the flow rate increases, and the lockup (setpoint rise) as flow decreases and approaches zero.

Maximum inlet pressure: 250 psig (17,2 bar)

Flow Coefficient: 0.8

Range Spring: 5-15 psig (0,34-1 bar)

Set Point: 10 psig / 15 psig

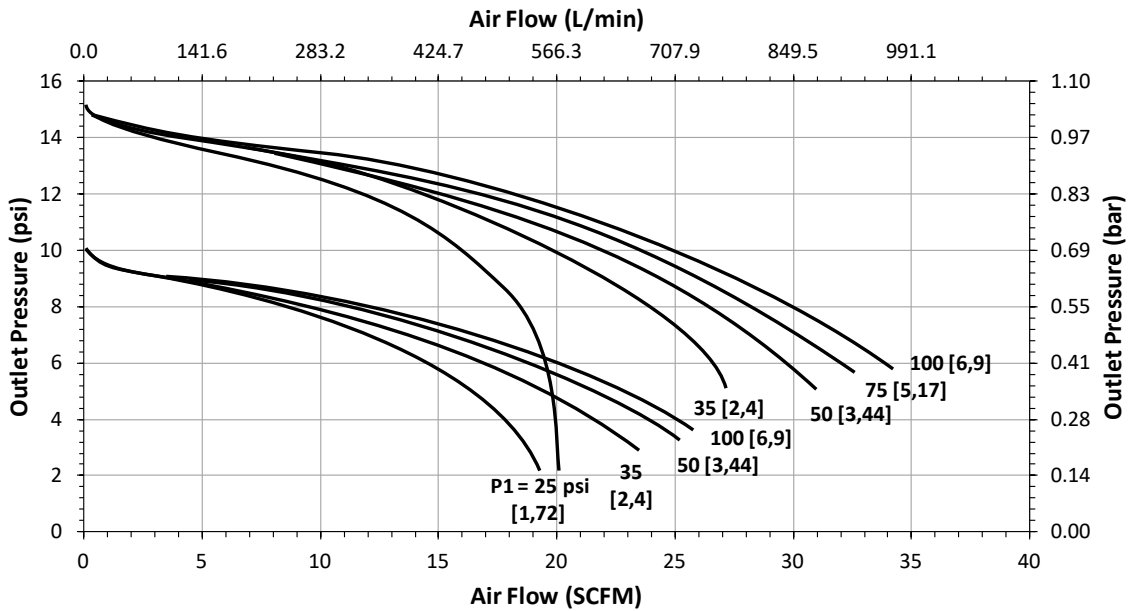

Flow Coefficient: 0.8

Range Spring: 5-15 psig (0,34-1 bar)

Set Point: 10 psig / 15 psig

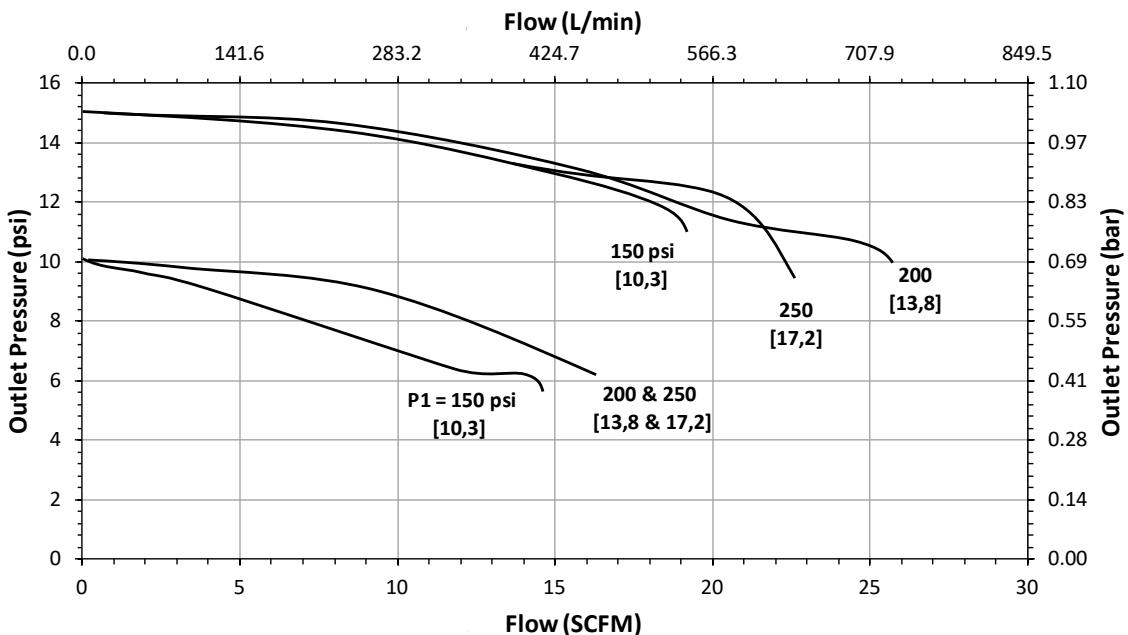

FLOW DATA FOR CV TRIM SELECTION

The graphs illustrate the change or "droop" in outlet pressures as the flow rate increases, and the lockup (setpoint rise) as flow decreases and approaches zero.

Maximum inlet pressure: 250 psig (17,2 bar)

Flow Coefficient: 0.8

Range Spring: 15-25 psig (0,3-1 bar)

Set Point: 20 psig

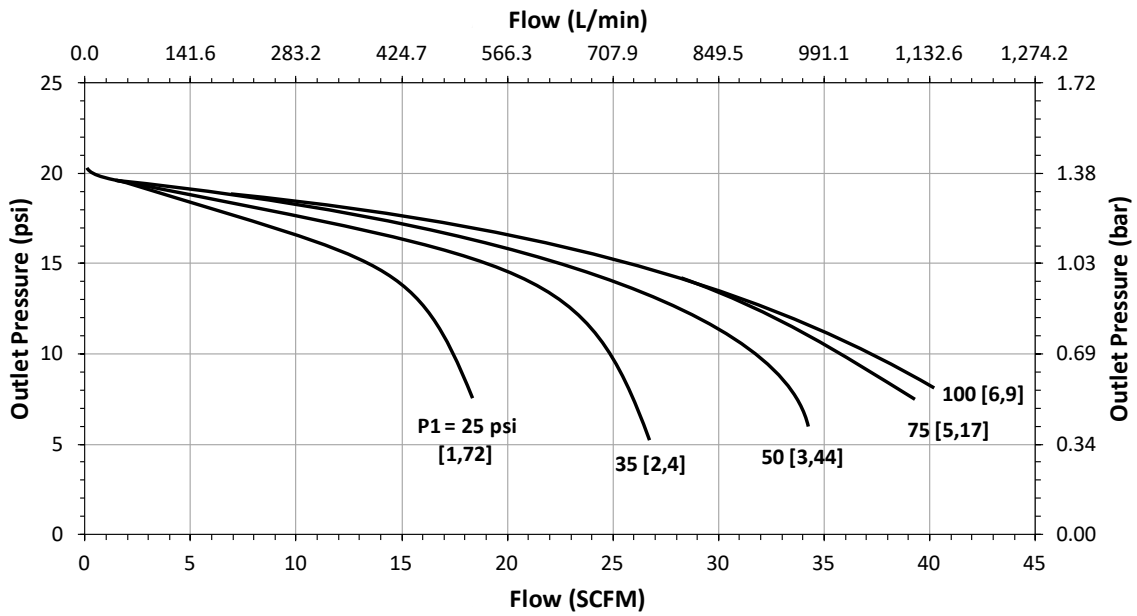

Flow Coefficient: 0.8

Range Spring: 15-25 psig (0,3-1 bar)

Set Point: 20 psig

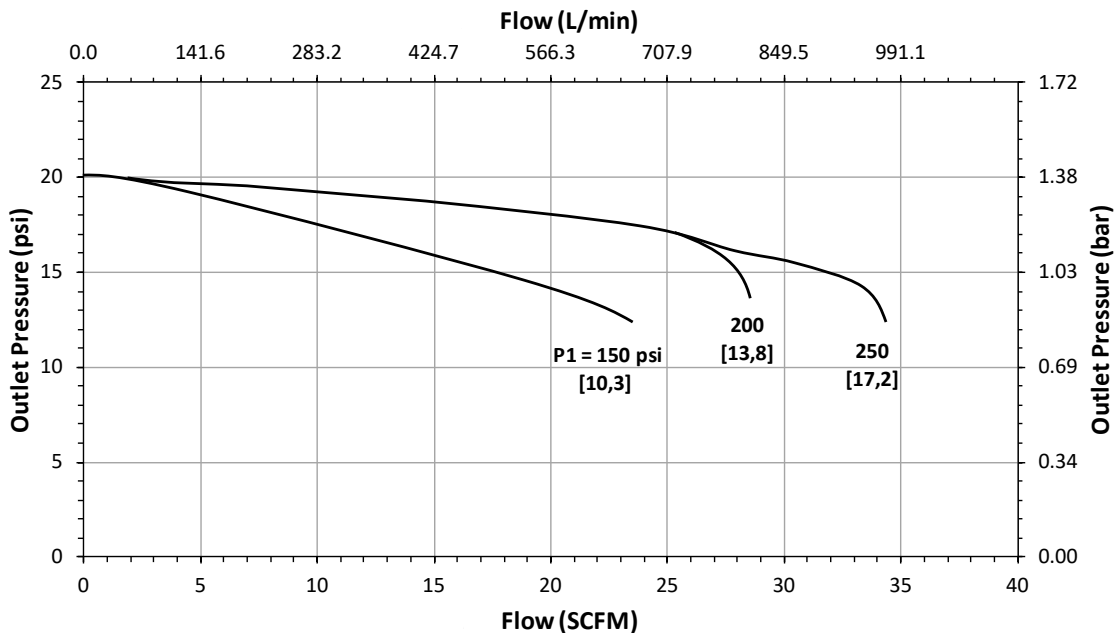

FLOW DATA FOR CV TRIM SELECTION

The graphs illustrate the change or "droop" in outlet pressures as the flow rate increases, and the lockup (setpoint rise) as flow decreases and approaches zero.

Maximum inlet pressure: 250 psig (17,2 bar)

Flow Coefficient: 0.8

Range Spring: 25-50 psig (1,7-3,4 bar)

Set Point: 25 psig / 35 psig

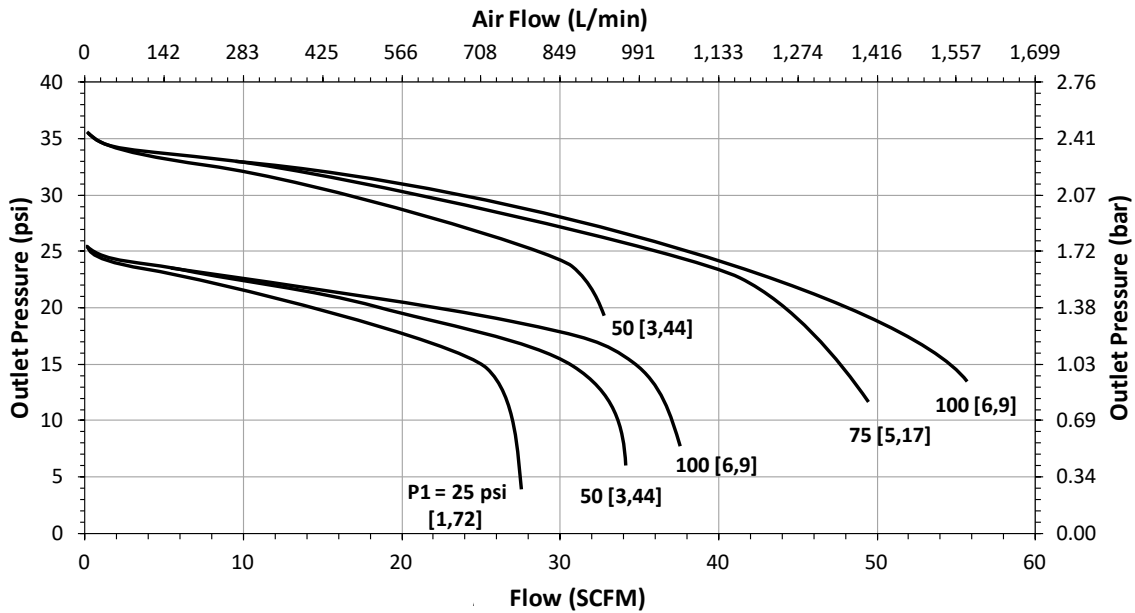

Flow Coefficient: 0.8

Range Spring: 25-50 psig (1,7-3,4 bar)

Set Point: 25 psig / 35 psig

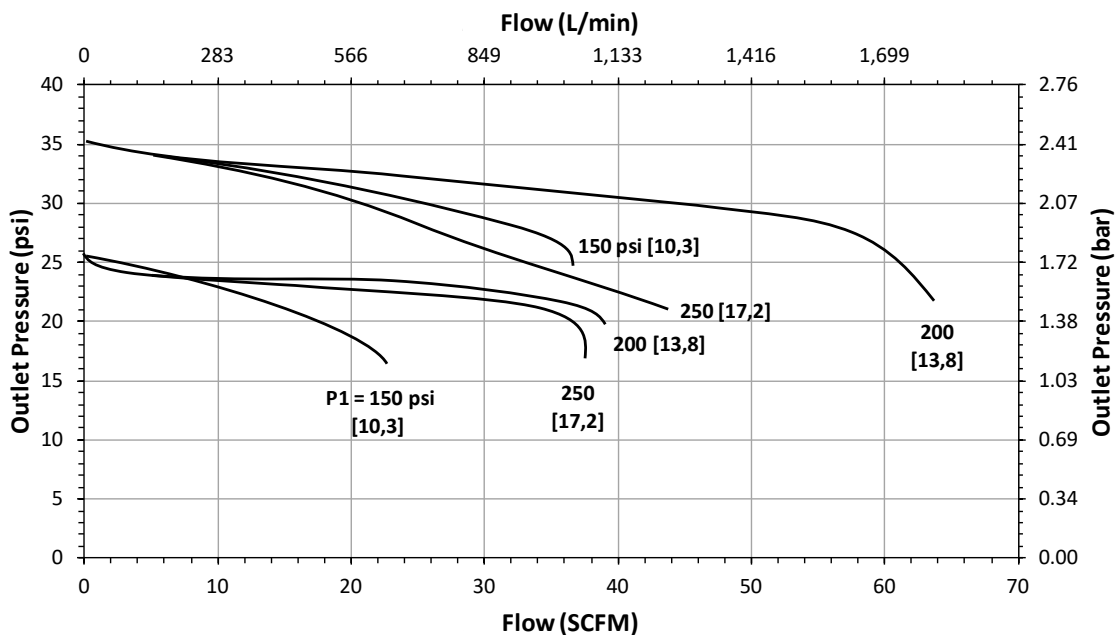

FLOW DATA FOR CV TRIM SELECTION

The graphs illustrate the change or "droop" in outlet pressures as the flow rate increases, and the lockup (setpoint rise) as flow decreases and approaches zero.

Maximum inlet pressure: 250 psig (17,2 bar)

Flow Coefficient: 0.8

Range Spring: 25-50 psig (1,7-3,4 bar)

Set Point: 30 psig/ 40 psig

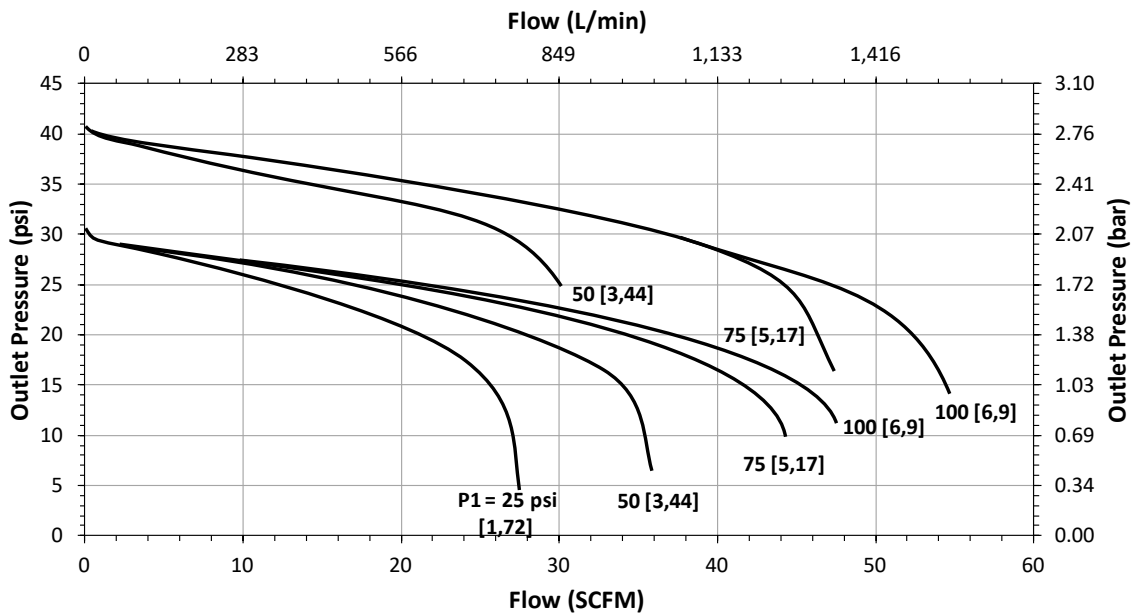

Flow Coefficient: 0.8

Range Spring: 25-50 psig (1,7-3,4 bar)

Set Point: 30 psig/ 40 psig

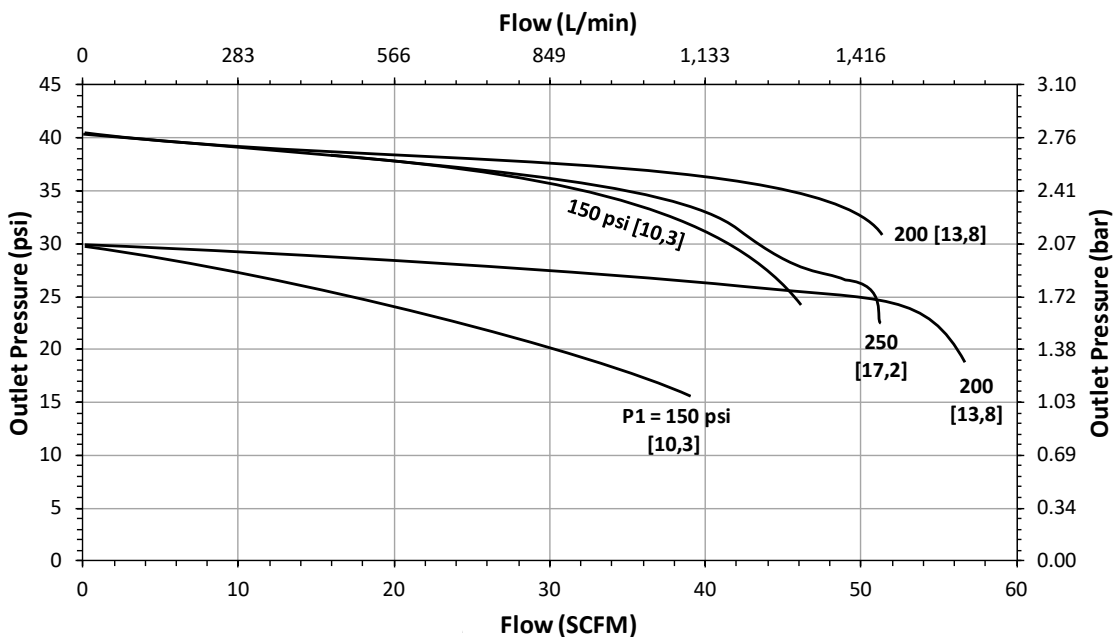

FLOW DATA FOR CV TRIM SELECTION

The graphs illustrate the change or "droop" in outlet pressures as the flow rate increases, and the lockup (setpoint rise) as flow decreases and approaches zero.

Maximum inlet pressure: 250 psig (17,2 bar)

Flow Coefficient: 0.8

Range Spring: 25-50 psig (1,7-3,4 bar)

Set Point: 45 psig/ 50 psig

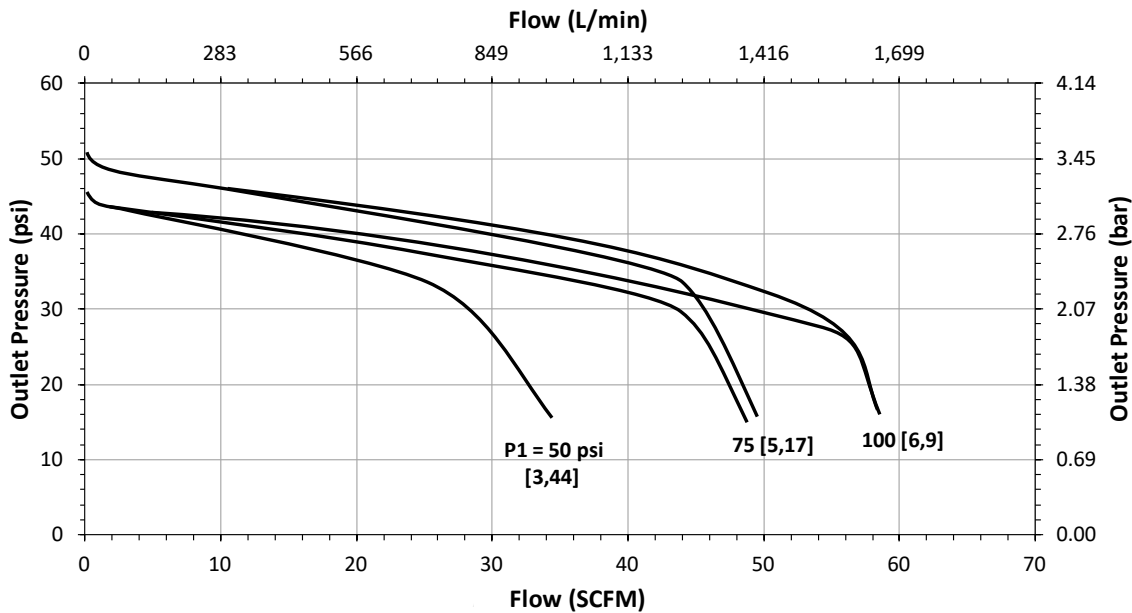

Flow Coefficient: 0.8

Range Spring: 25-50 psig (1,7-3,4 bar)

Set Point: 45 psig/ 50 psig

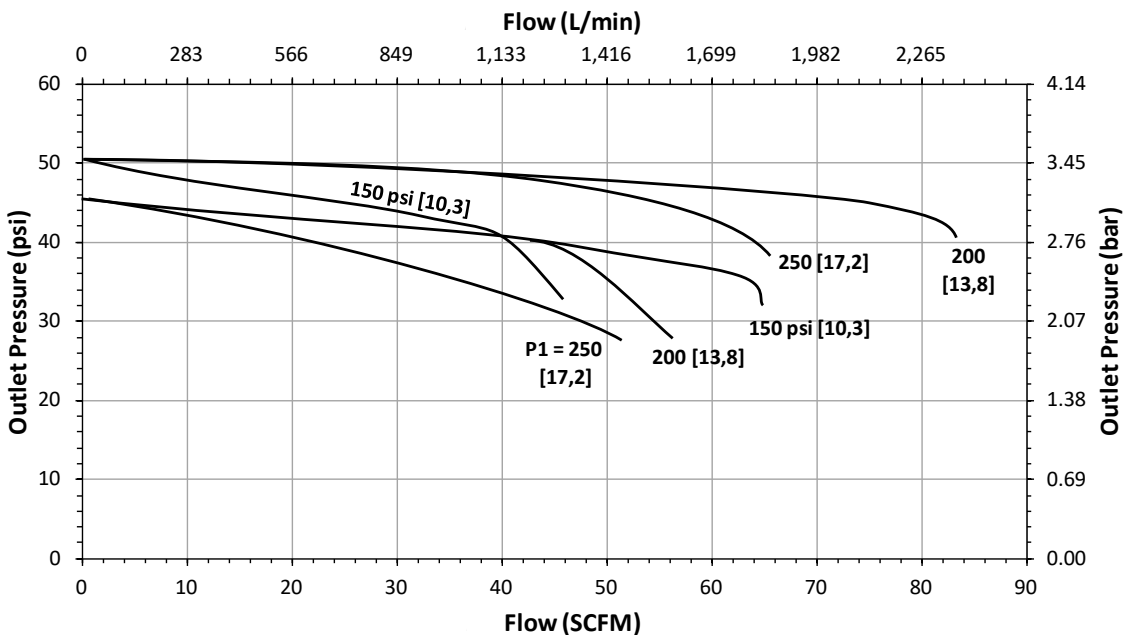

Model	Size	Material	/	1 & 2	3 & 4	5 & 6	7 & 8	9 & 10	11 & 12	13 & 14	15	16	17
	—	—											

Model	
JRHL	Low Flow Low Pressure Reducing Valve

Size	
050	1/2"
075	3/4"

Material	
6L	Stainless Steel 316L

1 & 2	Body Feature	
	End Connection	Port Configuration
C	FNPT 1/2"	A Port "A"
D	FNPT 3/4"	B Port "B"
		C Port "C"
		D Port "D"
		E Port "E"
		F Port "F"
		G Port "G"
		H Port "H"
		J Port "J"
		K Port "K"
		L Port "L"
		M Port "M"
		N Port "N"
		V Port "V"
		R Port "R"
ZZ	Non-Standard	

3 & 4		Trim
1S	Cv 0.8 (Kv 0,69)	
2S	Cv 0.5 (Kv 0,43)	
1R	Cv 0.8 (Kv 0,69) Self-Relieving	
2R	Cv 0.5 (Kv 0,43) Self-Relieving	
ZZ	Non-Standard	

5 & 6		Seat Material
TF	PTFE	
PK	PEEK	
EP	EPDM	
ZZ	Non-Standard	

7 & 8		Range Spring / Outlet Pressure
01	1-5 psi	
05	5-15 psi	
15	15-25 psi	
25	25-50 psi	
ZZ	Non-Standard	

9 & 10		Diaphragm Material
JL	Thin Jorlon™	
ZZ	Non-Standard	

11 & 12		Actuator
SK	Standard Actuator	
PM	Panel Mount	
CV	Captured Vent	
TP	Tamper Proof	
ZZ	Non-Standard	

13 & 14		Inlet Gauge
AA	0 - 30 psi / bar (Dual)	
BB	0 - 60 psig / bar (Dual)	
CC	0 - 100 psig / bar (Dual)	
DD	0 - 160 psig / bar (Dual)	
EE	0 - 200 psig / bar (Dual)	
NN	None	
ZZ	Non-Standard	

15		Outlet Gauge
A	0 - 100 psig/bar (Dual)	
B	0 - 160 psig / bar (Dual)	
N	None	
Z	Non-Standard	

16		SEP Compliance
G	SEP Compliant	
∅	None	
Z	Non-Standard	

17		Accessories
S	Clean For Oil Free*	
X	Clean For Oxygen*	
∅	None	
Z	Non-Standard	

*Consult factory for compatible gauge options

LowFlow Valve reserves the right to make revisions to its product, specifications, literature and related information without notice. Please visit our website at www.lowflowvalve.com for the latest information on our products.